

衛生及保健用品 Hygiene & Healthcare

Table Ware	餐具	25
Medicine	醫藥產品	27
Rubbish Bin	廢紙桶	31
Cleaning Product	清潔用品	33
Sanitizing Dispenser	消毒洗手機	38
Glove	手套	39
Health Care	保健產品	39
Tissue	紙巾	44
Air Purifier	空氣清新機	47



02

衛生及保健用品
Hygiene & Healthcare

GLAD
Glad Double Lock Bag
佳能密實袋

25 pcs/Box
M Size 17.8 x 20.3cm
• 160 0272001
50pcs/Box
M Size, 17.8 x 20.3cm
• 160 0364
40pcs/Box
L Size, 26.8 x 27.9cm
• 160 0365

UNIT Box 12



GLAD
Glad Wrap
佳能保鮮紙

300ft
• 160 0299
Microwave Wrap 微波爐鮮紙
100ft
• 160 0137

UNIT Box



GLAD
Glad Aluminium Foil Roll
佳能錫紙

12"x75ft
• 160 0301

UNIT Box 24



Diamond Aluminium Foil Roll
錫紙

12"x 25ft
• 162 1067

UNIT Roll



Plastic Food Bag
卷裝保鮮食物袋

200 bags / Roll
10" x 15"
• 005 6207

UNIT Box



Plastic Chinese Spoon
膠飯羹

144 pcs/ Pack
• 161 2059144

UNIT Pack 10



Deluxe Beige Chinese Rice Spoon 5"
優質中式湯羹

100 pcs/ Pack
SWCC, Beige 杏色
• 161 2216

UNIT Pack 20



Deluxe Black Plastic Fork 7" /
Spoon 6"
優質大膠叉膠羹

100 pcs/Pack
DKF-1000B-F107, Fork叉
• 161 2219
DKS-1000B-F206, Spoon羹
• 161 2220

UNIT Pack 10



Plastic Fork 5"
膠叉

200 pcs / Pack
• 161 2007200

UNIT Pack 15

200 pcs/ Pack
• 161 2040200

UNIT Pack 20



Plastic Stirrer 5.5"
膠攪羹

1000pcs/Pack
PSS
• 161 2023
6400
• 161 2235

UNIT Pack 3

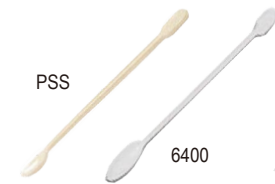

Strip Flex Plastic Straw with
plastic bag
彩色飲管連膠套

180 pcs/ Pack
• 161 2258



Paper Straw
紙飲管

25 pcs/ Pack
6 x 197mm
• 161 2331

UNIT Pack 400



Wooden Toothpicks
牙簽

Tube of 200 pieces
• 161 2025

UNIT Tube 4

Individual Paper Wrapped
獨立紙包單支雙頭
TPW-5M, Pack of 2500
• 161 2221

UNIT Pack 10



Bamboo Chopstick 21mm
竹筷子

100 pairs/Pack
• 161 2006

UNIT Box



Wooden Stirrer
木攪雪條棍

50 pcs/Pack
• 161 2104

UNIT Pack 200



TABLE WARE 餐具



161 2218 161 2002 161 2234 161 2027050 161 2205 161 2069

Code	Description 說明	Brand / Mode 品牌 / 型號	Volume 容量	Packing
161 2218	Poly Paper Handled Hot Cup 有耳熱飲紙杯	SOLO 378HSM	8oz	50pcs/Pack $\left\{ \begin{array}{l} 20 \\ \downarrow \end{array} \right.$
161 2002	Trophy Cup 纖維杯	SOLO X8-J8002	8oz	100pcs/Pack $\left\{ \begin{array}{l} 10 \\ \downarrow \end{array} \right.$
161 2234	Heat Barrier Cup 隔熱杯	Josco HB8CAFE	8oz	50pcs/Pack $\left\{ \begin{array}{l} 20 \\ \downarrow \end{array} \right.$
161 2027050	Hot Paper Cup 熱飲有花紙杯	--	8oz	50pcs/Pack $\left\{ \begin{array}{l} 20 \\ \downarrow \end{array} \right.$
161 2205	Plastic Lid 膠蓋	--	--	100pcs/Pack ---
161 2069	Hot Drink White Paper Cup - Thick 淨白厚身紙杯	--	8oz	50pcs/Pack $\left\{ \begin{array}{l} 20 \\ \downarrow \end{array} \right.$

UNIT Pack

* 提供個性化服務：可印刷企業 LOGO、廣告等，如有需要請聯絡我們。



161 2047 161 2293 161 2207 161 2251 161 2013 Paper Plate PS Paper Plate

Code	Description 說明	Brand / Mode 品牌 / 型號	Volume 容量	Packing
161 2047	White Paper Cup 白熱飲紙杯	--	4oz	100pcs/Pack $\left\{ \begin{array}{l} 20 \\ \downarrow \end{array} \right.$
161 2293	White Paper Cup 白熱飲紙杯	--	6oz	50pcs/Pack $\left\{ \begin{array}{l} 40 \\ \downarrow \end{array} \right.$
161 2207	Clear Plastic Cup 透明膠杯	--	7oz	50pcs/Pack $\left\{ \begin{array}{l} 40 \\ \downarrow \end{array} \right.$
161 2251	Clear Plastic Cup 透明膠杯	--	2oz	2400pcs/Pack ---
161 2013	White Conical Paper Cup 白色蒸餾水尖杯	SOLO 4CP	4oz	250pcs/Pack $\left\{ \begin{array}{l} 20 \\ \downarrow \end{array} \right.$

Size	White Paper Plate 白紙碟	PS White Plastic Plate PS物料白色膠碟	Packing
7"	161 2083	161 2198	100pcs/Pack $\left\{ \begin{array}{l} 20 \\ \downarrow \end{array} \right.$
9"	161 2084	161 2199100	100pcs/Pack $\left\{ \begin{array}{l} 40 \\ \downarrow \end{array} \right.$

UNIT Pack

UNIT Pack

Plastic White Table Cloth 膠檯布

- 50pcs/Pack
- Size: 51" x 51"
- **162 1061**
- Size: 66" x 66"
- **162 1153**

UNIT Pack



Plastic Litter Bags 垃圾袋

UNIT Pack

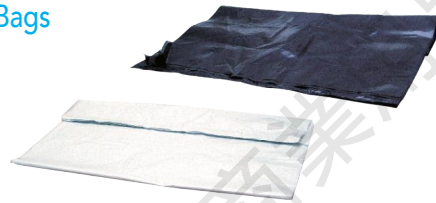

Code 產品編號	厚度(mm)	Size (吋) 尺寸	Packing
162 1097	0.05 / 黑	48" x 56"	100
162 1002	0.05 / 黑	36" x 48"	100
162 1145	0.05 / 黑	34" x 36"	100
162 1051	0.05 / 黑	24" x 36"	100
162 1003015	0.01 / 黑	24" x 24"	100
162 1066015	0.02 / 黑	26" x 36"	50
162 1276	0.05 / 黑	32" x 40"	100
162 1054	0.02 / 黑	32" x 40"	50
162 1003	0.01 / 白	24" x 24"	100
162 1093	0.01 / 白	24" x 30"	100
162 1054085	0.02 / 白	32" x 40"	50

02

衛生及保健用品

Hygiene & Healthcare

02

衛生及保健用品

* IAT LEI 並非產品製造商，只提供代購服務

Lee Chung Shing Tong Po Chai Pills
李眾勝堂-保濟丸

10 bottles/Box
• 160 0013

UNIT Box



White Flower Oil
白花油

20ml/Bottle
• 160 0144

UNIT Bottle



Dequadin Lozenges
得果定喉片

18 tablets/Box
Orange 橙味
• 160 0269

Extra 得果適特效
8 tablets/Box
Lemon & Honey 檸檬蜜糖味
• 160 0270

UNIT Box 12



Cortal Adult
克痛大人藥片

20 tablets/Box
• 160 0103

UNIT Box 10



Actal Tablets
益達胃胃藥

20 tablets/Box
• 160 0027020

UNIT Box



Panadol Extra Tablets
特效必理痛

10 tablets/Box
• 160 0029

UNIT Box 12



Panadol Cold & Flu Caps
必理痛傷風感冒丸

20 tablets/Box
• 160 0026
30 tablets/Box
• 160 0308

UNIT Box 12



Panadol Extra Cold & Flu Caps
必理痛特強傷風感冒丸

8 tablets/Box
• 160 0106

UNIT Box 20



Panadol Tablets
成人必理痛

24tablets/Box
• 160 0391

UNIT Box NEW



16 tablets/Box
• 160 0199

UNIT Box 12



Trumpet Seirogan(Sugar)
喇叭牌正露丸(糖衣裝)

36 pills/Bottle
• 160 0256

UNIT Bottle



Imodium Tablets
速治靈

8 tablets/Box
• 160 0100

UNIT Box



Coltalin Cold Tablet
無睡意幸福傷風素

12pill/Box
• 160 0003
24pill/Box
• 160 0003024

UNIT Box



Coltalin Magsil Tablet
幸福胃的素

24 pills/Pack
• 160 0185

UNIT Pack 12





CANCARE®
"We can care for you"

加護™

加拿大個人護理產品品牌

健康監察

傷口護理

急救用品

個人防護

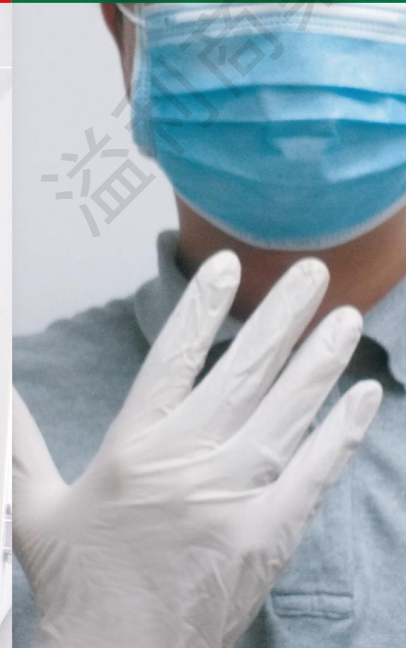
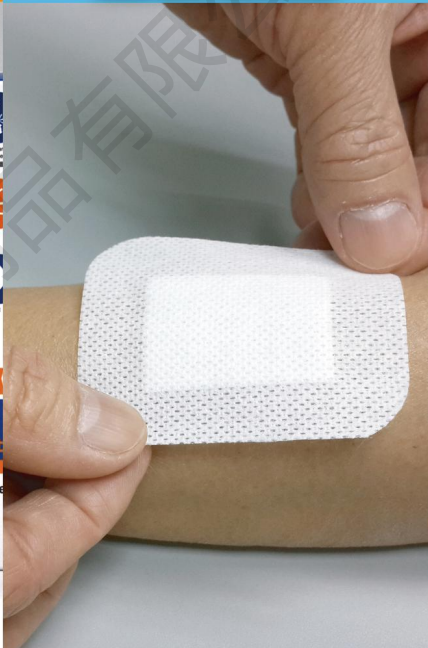

Cancare First Aid Box Supplies Set
加護™ 急救安全箱設備套裝

- Mounting Accessories Included. Conforms to Labour Department's "Hints on First Aid" requirements for first aid box in all other workplaces(Appendix 5). Suitable for offices and factories.
- 內附掛牆組件，符合勞工處職業安全及健康部規定所有其他工作地點(附錄五)，適合所有其他工作地點備用。



Cancare First Aid Box Refill
加護™ 急救安全箱設備補充裝

- An essential first aid box under Labour Ordinance for company. Conforms to Labour Department's "Hints on First Aid" requirements for first aid box in all other workplaces(Appendix 5)
- 勞工法例規定公司的急救箱設備規定所有其他工作地點(附錄五)，適合所有其他工作地點備用。



UNIT Set

First Aid Box Supplies Set 急救箱設備	1-9 employees 1-9 人以下公司套裝	under 50 employees 50人以下公司套裝	50-100 employees 50-100人公司套裝
Code	160 0105	160 0058	160 0209
First Aid Box 標準型安全藥箱	1 pcs	1 pcs	1 pcs
AlcoholPreps™100pcs 加護™消毒酒精棉	1 box	1 box	1 box
CrepeBand™ 3" Bandage 加護™彈性繃帶 3"	1 pack	2 packs	2 packs
CottonWool™ 35g 加護™脫脂藥棉 (35克)	1 pack	3 packs	5 packs
ExamGloves™ Latex Examination Gloves 加護™醫用手套 (中碼)	2 pairs	4 pairs	4 pairs
GauzePad™ 2"x2" (Sterile) 5 pcs 消毒紗墊	1 pack	2 packs	4 packs
GauzePad™ 3"x3" 5 pcs (Sterile) 消毒紗墊	1 pack	1 pack	4 packs
TransPlaster™ Assorted 加護™多款透明膠布	1 box	1 box	1 box
TriBand™ Triangular Bandage 加護™三角繃帶	1 pcs	2 pcs	4 pcs
WoundDressing™ 6x7cm 6 pcs 加護™傷口貼	1 pack	1 pack	2 packs
WoundDressing™ 6x10cm 3 pcs 加護™傷口貼	1 pack	1 pack	2 packs
WoundDressing™ 9x10cm 3 pcs 加護™傷口貼	1 pack	1 pack	2 packs
ZincOxidePlaster™ 1"x10yds 氧化鋅膠布	1 rolls	1 rolls	2 rolls
First Aid Guide 急救指南	1 sheets	1 sheets	1 sheets
Scissor 剪刀	1 pair	1 pair	1 pair
Safety Pin 安全扣針	3 pcs	6 pcs	12 pcs

UNIT Pack

Contents	1-9 ppl	10-49 ppl	50-100 ppl
Code	160 0252	160 0253	160 0254
AlcoholPreps™100pcs 消毒酒精棉	1 box	1 box	1 box
CrepeBand™ 3"彈性繃帶	1 roll	2 rolls	2 rolls
CottonWool™ 35g 脫脂藥棉	1 bag	3 bags	5 bags
ExamGloves 中碼 醫用手套	2 pairs	4 pairs	4 pairs
GauzePad™ 2"x2" (Sterile) 消毒紗墊	5 pcs	10 pcs	20 pcs
GauzePad™ 3"x3" (Sterile) 消毒紗墊	5 pcs	5 pcs	10 pcs
TransPlaster™ Assorted 多款 透明膠布	24 pcs	24 pcs	24 pcs
TriBand™ 三角繃帶	1 pcs	2 pcs	4 pcs
WoundDressing™ 6x7cm 傷口貼	6 pcs	6 pcs	12 pcs
WoundDressing™ 6x10cm 傷口貼	NA	3 pcs	6 pcs
WoundDressing™ 9x10cm 傷口貼	3 pcs	3 pcs	6 pcs
ZincOxidePlaster™ 1" 氧化鋅膠布	1 roll	1 roll	2 rolls
First Aid Guide 急救指南	1 pcs	1 pcs	1 pcs
Scissor 剪刀	1 pair	1 pair	1 pair
Safety Pin 安全扣針	3 pcs	6 pcs	12 pcs

02

Hygiene & Healthcare 衛生及保健用品



Code	Description 說明	Model>型號	Size>尺寸	Plaster Colour 膠布顏色	Number of Plaster 膠布數量
010 0007	Nexcare™ Waterproof Bandages		26 x 57mm	Clear	20
010 0008	Nexcare™ Tegaderm™		50 x 70mm	Clear	5
160 0294	Cancare FabricPlast™		19 x 72mm	Skin	60
160 0265	Cancare TransPlaster™		10pcs-19 x 72mm, 10pcs-12 x 53mm, 1pc-40 x 72mm, 1pc-38 x 56mm(Butterfly), 2pcs-22mm(round)	Clear	24
160 0293	Cancare TransPlaster™		Standard & Small>20pcs-19 x 72mm, 5pcs-12 x 53mm	Clear	25
160 0292	Cancare TransPlaster™		19 x 72mm	Clear	60
010 0005	Nexcare™ Bandages		19 x 75mm	Clear	100
010 0006	Nexcare™ Bandages		19 x 75mm	Skin	100
010 0012	Nexcare™ Comfort Blue Bandage		22 x 57mm	Blue	100
160 0012	Banitore Sheer Type Plaster		19 x 72mm	Semi-Clear	100
160 0114	Banitore Protective Plaster		53 x 72mm	Skin	5

Nexcare

Nexcare™ No Sting Liquid Spray Bandage 無刺痛噴霧保護膜

- Used in minor skin scrapes and abrasions.
- It is alcohol free and doesn't sting when applied.
- The thin shield provides a soothing, breathable, waterproof protection that promotes healing of skin.
- 適用於皮膚擦損及細面積傷口。
- 不含酒精，不會令傷口刺痛。
- 施噴後傷口表面會形成一層薄薄的防水保護膜，舒緩傷口同時又不阻礙皮膚呼吸，促進皮膚癒合。



118-03, Bottle of 18ml, Appox. 60 times
 • 010 0010
 UNIT Bottle 6

Betadine Dry Powder Spray 必妥碘殺菌乾粉噴霧

- Kills germs quickly to prevent infections in minor cuts, wounds, abrasions and burns. Individual response varies
- 適用於灼傷、割傷、刮傷和擦傷等傷口消毒，有助預防病菌感染。



55g
 • 160 0349
 UNIT Bottle 12

Banitore Vapor Spray Dressing 便利妥噴霧膠布

- Waterproof, Bateriaproof, Breathable
- 透氣、防菌、防水 50ml
- 160 0092



UNIT Bottle 12

Cancare Zinc Oxide Acetate Silk Tape 加護™ 膚色卷裝膠布

25mm x 5m
 • 160 0041
 UNIT Roll 12



Safety Pins 安全扣針

12 pcs/Pack
 • 160 0098
 UNIT Pack



First Aid Scissor 急救剪刀

• 160 0099
 UNIT Pair



Nexcare™ Micropore Surgical Tape with Dispenser 醫生紙膠布

- Light, breathable
- Hypoallergenic
- Stationary upholstered
- 輕便透氣、防敏感、固定軟墊



1535LP-1, 1" x 10yds with dispenser 連切割座
 • 160 0350
 UNIT Pc 12

3M Surgical Tape 醫生膠布

- Lightweight and Breathable;
- Hypoallergenic, gentle to skins; Ideal for security bandages or dressings.
- 輕便透氣、防敏感、固定軟墊



1/2" x 10yds
 • 160 0107
 UNIT Roll

Betadine Antiseptic Solution 必妥碘傷口殺菌液

- to clean up, disinfect cuts, scratches and burns.
- 可用來清潔、消毒割傷、擦傷和燙傷等傷口



30ml
 • 160 0341
 UNIT Bottle 8





Cancare Cotton Wool™
加護™ 脫脂藥棉

- 100% Pure & high quality Cotton
 - Ideal for baby care, cosmetic use, health care & personal hygiene
 - 100%高級純棉製造
 - 適用於嬰兒及個人護理,日常化妝
- Cancare CottonWool™ Absorbent Cotton Wool
加護™ 脫脂藥棉
35g/ Pad

- **160 0042**
- Cancare CottonBall™
加護™ 脫脂藥棉球
80 pcs/ Pack

- **160 0088**

UNIT Pad



Cancare TriBand™ Triangular Bandage
加護™ 三角繃帶

- Individually Packed.
 - Made of 100% gauze
 - 獨立包裝
 - 純棉紗製造
- 36" x 36" x 51"
• **160 0097**

UNIT Pc



02



Cancare Elastic Bandages
加護™ 彈性繃帶

- 50mm x 5.5m
- **160 0093**
 - **160 0094**

UNIT Roll



Cancare GauzePad™ (Sterile)
加護™ 消毒紗墊

- 5pcs/Pack
50mm x 50mm (2" x 2")
- **160 0095**
 - **160 0096**
 - **160 0108**

UNIT Pack



Cancare Wound Dressing™
加護™ 傷口貼

- Sterile, Non-adherent absorbent pad, Hypoallergenic adhesive.
 - 消毒、附有不黏傷口吸水墊、低敏度。
- 6x7cm, 6 pcs/Pack

- **160 0237**
- **160 0238**
- **160 0250**
- **160 0239**

UNIT Pack



Cancare Wound Carekit
加護™ 傷口護理包

- Suitable for household and travelling.
 - 適合一般家庭及旅行備用
- **160 0251**

UNIT Box



Banitore First Aid Box
安全藥箱

- D105 x W280 x H280mm
- **160 0030**

UNIT Pc



Cancare First Aid Box Portable
加護™ 手提急救箱

- Suitable for Construction sites, Factories and Outdoor Offices. Easy to Carry
 - 適合地盤或工地備用,方便攜帶
- D127 x W311 x H324mm
Black

- **160 0072**

UNIT Pc



Banitore Spiral Cotton Bud
便利妥棉花棒

- 80pcs/Pack
- **160 0189**

UNIT Pack



Adhesive Sterile Gauze Pad
黏性紗布

- 50 x 75mm
- **160 0151**
 - **160 0152**

UNIT Pc



Bandages
繃帶

- 2" x 6yds
- **160 0223**
 - **160 0224**

UNIT Roll



Contents	Qty
ExamGloves 中碼 醫用手套	1 pairs
GauzePad™ 2"x2" (Sterile) 消毒紗墊	2 pcs
GauzePad™ 3"x3" (Sterile) 消毒紗墊	2 pcs
SurgicTape™ 1"x10yd 醫用透氣紙膠布	1 roll
CrepeBand™ 3"彈性繃帶	1 roll
AlcoholPreps™100pcs 消毒酒精棉	10 pcs
WoundDressing™ 6x7cm 傷口貼	2 pcs
WoundDressing™ 6x10cm 傷口貼	2 pcs
Scissor 剪刀	1 pair
TransPlaster™ Assorted 多款透明膠布	24 pcs

衛生及保健用品

Hygiene & Healthcare

Rubbish Bin with Cover & Footstep
有蓋腳踏廢紙桶

02

衛生及保健用品
Hygiene & Healthcare



Code 產品編號	Model	Capacity (litres) 容量(公升)	Size (mm) 尺寸
004 7016	ART410	5	Ø225 x H260
004 7003	GE412	18	Ø320 x H425
004 7026	GE417	10	D250 x W297 x H325
004 7004	GE418	16	D311 x W355 x H385
004 7036	ART419	22	D360 x W220 x H427
004 7014	ART428	45	D326 x W432 x H540
004 7036032	GEO70	70	D400 x W503 x H665
004 7086	GEO95	95	D400 x W498 x H840

Rubbish Bin With Cover
有蓋廢紙桶



Code 產品編號	Model	Capacity (litres) 容量(公升)	Size (mm) 尺寸
004 7005	ART414	32	D390 x W282 x H589
004 7031	GEO42	42	D315 x W418 x H630
004 7025	GEO58	58	D328 x W467 x H752
004 7032	GEO60	60	Ø453 x H815
004 7015	GEO90	90	Ø525 x H910

Rectangular Recycle Rubbish Bin With Lid
有蓋分類廢紙桶

- GEO 58S and GEO 58P included waste sorting sticker
- GEO 58S 及 GEO 58P 附三角貼紙(黃鋁罐/啡膠樽/藍廢紙)
- Size : D463 x W336 x H80mm, 58L
- GEO58C, Circle hole diameter: 90mm
- Yellow

• 004 7039

Brown

• 004 7070

GEO 58P, Rectangular Hole length: 220mm

Blue

• 004 7040

UNIT Pc



M&G Mesh Round Litter Bin
晨光網紋垃圾桶

ALJ99402
H285 x 260mm (dia.)

• 004 7022

ALJ99403
H340 x 295mm (dia.)

• 004 7081

UNIT Pc

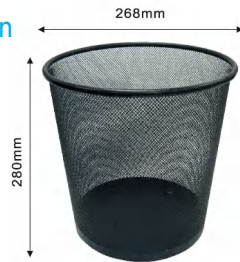

GEO58S, Swing Lid (搖蓋)
Door Width : 205mm
Grey

• 004 7028



Rubbish Bin
廢紙桶

Approx: D200 x W240 x H285mm

Grey

• 004 7001012

UNIT Pc



Rectangular Step-on Classified Dustbin with Spring Cover
雙蓋分類廢紙桶

4051, Double Lid
Size :D273 x W350 x H425mm

10L x 2

• 004 7080

UNIT Pc



Stainless Steel Rubbish Bin W/String Cover
不銹鋼平面搖蓋垃圾桶

H645 x 305mm (dia)

• 004 7085

UNIT Pc



Stainless Steel Step Bin
不銹鋼垃圾桶

φ21 x 32cm, 7L

• 004 7050

φ24.8 x 40cm, 12L

• 004 7046

φ29.2 x 44.5cm, 20L

• 004 7047

φ29.2 x 64cm, 30L

• 004 7048

UNIT Pc



Rectangular Step-on Dustbin With Spring Cover
彈蓋腳踏廢紙桶

UNIT Pc

Code產品編號	Model	Capacity (litres)容量(公升)	Size (mm) 尺寸
004 7088	4046	12	D220 x W285 x H377
004 7089	4042	19	D340 x W250 x H430
004 7090	4043	30	D390 x W290 x H505
004 7093	4044	45	D445 x W335 x H560



02

衛生及保健用品

Hygiene & Healthcare

02

Air Dryer (With Handle and Wheel)
三段速吹風機 (行李式)

- 功率 : 900W
- 重量 : 20 Kgs
- 風量 : 110,130,160 cum/min.
- L570 x W420 x H620mm, 20kg

• 009 9375

UNIT Pc



IPC Dry Vacuum Cleaner
吸塵機

- 功率:900W
- 電線長度:8.5M
- 吸力 : 158m²/h
- 噪音 : 63db(A)
- 能源標籤 : 歐盟B級
- L400 x W400 x H330mm, 5.8kg
- 2ECO B, 12L

• 009 9422

UNIT Set



Round Pail 18ltr with Lid
圓形萬用桶連蓋

250/250-1

• 009 9170

UNIT Set



White Towel
白色毛巾

12 pcs/Pack
Size:13" x 28"
"新"字薄身

• 162 1001

"合"字厚身

• 162 1106

UNIT Pack



Slippery Surface Floor Notice Sign
小心地滑座地告示牌

- To avoid any accident on slippery surface
- 預防因地滑而引致的意外

W248 x H577, A字型

Yellow

• 160 0121

8204, D319 x W319 x H907mm,

筒型

Yellow

• 160 0381

UNIT Pc



A字型



筒型

Bucket with Wringer
實用水桶

D23 x W39 x H29cm

• 162 1090

UNIT Pc



Square Towel
方巾

Size: 12" x 12"

• 162 1238

UNIT Pc



3M

3M™ Nomad Floor Mat-Red
3M™ 地毯

- Entrance coiled vinyl scraper matting with foam backed designed for low traffic applications. The construction allows dirt and moisture to flow through becoming trapped at the backing.

- 彈性鏤空式線圈設計, 能有效地將鞋底泥塵污垢刮除, 並暫收墊內; 亦可刮除鞋底水份, 大大減低滑倒意外。

45x60cm, red

• 019 9009

60x90cm, red

• 019 9007

UNIT Pc



Vileda Easy Wring & Clean Set
微力達旋風桶地拖套裝及替換裝

- 採用嶄新的腳踏式脫水設計, 轉速可達每分鐘1,000轉; 特設水擋, 防止水花四濺 不銹鋼軸心, 能承受腳踏50,000次; 三角型地拖, 有效清潔屋企每個角落

147737

• 162 1166

UNIT Set



Broom w/Handle
掃把連棍

• 162 1019

UNIT Pc

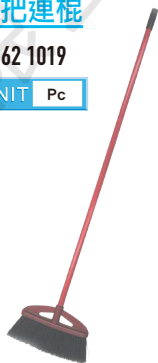

Mop Floor with Handle
地拖連棍

• 162 1010

UNIT Pc



Dust Pan w/Handle
有柄垃圾刮

• 162 1091

UNIT Pc



Toilet Pump
膠柄廁所泵

• 162 1098

UNIT Pc



Toilet Brush with Stand
廁所刷連座

BH-449

• 162 1111

UNIT Set





Scotch-Brite™ Dual Spin Contractible Spin Mop Set 思高™ 雙旋抽屜式旋轉拖把套裝

- Dual spin to wring dry & wring clean
- Contractible bucket takes up less storage space
- Hand press easy spin dry
- Easy clean microfiber mop is highly absorbent and features 3M™ Scotchgard™ stain resistant treatment
- Extendable handle for various uses
- Rotates 360o to penetrate gaps
- 雙旋設計-輕鬆脫水兼清洗
- 抽屜式水桶-儲存方便省空間
- 輕鬆手壓式脫水-雙腳站立不易滑動
- 易潔超微纖維-經3M™ 思高潔™ 防污處理, 更易清潔, 吸水力強
- 伸縮手柄-適合不同用途
- 360度靈活轉動-深入縫隙

T3

• 162 1328



Scotch-Brite™ Bottle Cleaner – Delicate Duty Non-scratch 思高™ 水樽清潔刷 – 防刮細緻清潔

- Zero-Scratch Non-woven web is suitable for Stainless Steel Bottle with coating inside, Plastic Water Bottle, Glass Bottle, Milk bottle
- Anti-bacterial Sponge - Sanitary and for better hygiene
- Knife-shape Scrubbing Head - Effective cleaning for hard-to-reach area
- More surface contact to the sides in one move & reach bottom corners
- 塗層保溫瓶、膠水樽、玻璃樽、奶樽專用
- 抗菌海綿刷頭, 迅速去污而不損器皿表面
- 獨特刀形刷頭, 斜角剛好貼合瓶底, 深入清潔樽內難擦位置
- 海綿前端的另一邊是圓形, 就算是較窄的瓶口, 也能輕鬆插入
- 刷底斜角, 輕鬆清潔邊位
- 替換式專用刀形刷頭, 方便衛生

DBC01

• 162 1329

DBC01R (Refill)

• 162 1330

UNIT Pc



Scotch-brite Tri-Function Sponge Mop 思高™ 3效吸水棉拖把

- Hand-free wringing system for comfort and cleanliness
- Highly absorbent sponge traps water quickly
- 免沾手設計, 不需用手擰乾, 方便衛生
- 高級膠棉, 吸水力強
- 兩側備夾布扣, 可配合抹布使用
- 人體工程學手柄及伸縮杆設計

Sponge Mop 吸水棉拖把

0088HK

• 162 1331

Refill 補充裝

0089HK

• 162 1332

UNIT Set



Scotchgard™ Fabric & Carpet Cleaner 思高潔™ 布質衣物及地毯清潔劑

- breaking up dirt and lifting out stains
- Cleans and refreshes fabric and carpet
- 適合清潔大範圍面積
- 深入布料及地毯纖維, 除去污垢, 起出污漬
- 不留黏性殘餘物

4107-16, 16.5oz

• 012 1029

UNIT Pc



Scotch-Brite Easy Sweeper Set 思高™ 除塵拖把

- The special weave of the sheet securely traps dirt and dust
- Disposable cloths to stay clean and hygienic
- Flexible mop plate rotates degrees to penetrate under furniture furniture
- Extendable handle easily cleans floors, walls and ceilings
- 360 度旋轉拖板, 方便深入縫隙
- 伸縮手柄輕易清潔地板、牆壁及伸縮手柄輕易清潔地板、牆壁及天花
- 軟膠坑紋底板, 加強清潔效能
- 可配合即棄乾紙或濕抹布使用

1拖把+5片除塵乾紙

Q600HK

• 162 1300

UNIT Set

Dry Dusting Cloths Refill

Refill 補充裝

833HK 30片

• 162 1301

833HK-200 200片

• 162 1369

UNIT Pack



Scotch-Brite Broom Comb Dustpan Set 思高™ 掃把連垃圾剷及梳刮套裝

- Flowered ends of Fibers Soft, flexible rubber edge Sweep dirty broom against comb
- 一站式套裝方便置放, 加上獨特的聰明梳刮, 讓帶毛黏塵的問題一掃而空

BD750

• 162 1333

UNIT Set

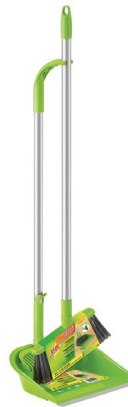

Scotch-Brite Mop with Handle 思高牌地拖連棍

Cotton 棉質(圓繩)

0094HK

• 162 1045

UNIT Set

Refill 補充裝

0096HK

• 162 1046

UNIT Pc



02

衛生及保健用品

Hygiene & Healthcare

02

衛生及保健用品
Hygiene & Healthcare

WD40 Lubricate Spray
潤滑劑

191ml, 6.5oz
• 162 0066

UNIT Bottle 24



BioKill Universal Insecticide
保而剋全效滅蟲劑

500ml
• 162 4035

UNIT Bottle 12



Alcohol 75%
消毒火酒75%

430ml
• 160 0011
230ml
• 160 0205
1000ml
• 160 0141
1 Gallon
• 160 0148

UNIT Bottle



Dettol Antiseptic Germicide
滴露消毒藥水

1200ml
• 162 4006
750ml
• 162 4013

UNIT Bottle



Polyclean SuperStrong Bleach
保潔麗漂白水

1 Gallon
• 162 0049

UNIT Bottle 4



Polyclean Greenwater
保潔麗超力綠水

1 Gallon
• 162 0048

UNIT Bottle 4



Raid Roach Bait
雷達蟑螂藥餌

8(6+2)pcs/Box
• 162 4040

UNIT Box 12



Ultra Clorox Bleach
高樂氏漂白水

2800ml
Original
• 162 1076
Lemon
• 162 1109

UNIT Bottle 6



SWIPE
SWIPE Concentrate
Multi-Purpose Blue
Cleaner
藍威寶濃縮清潔劑

• 有效去除任何油漬、污漬
1000ml

• 162 1016

UNIT Bottle 10



SWIPE
SWIPE Dish Washing
Detergent
紅威寶廚具清潔劑

• 適合洗手及洗碗碟用
1000ml
• 162 1025
with Pump 連噴咀
• 162 1101001

UNIT Bottle 10



Magiclean Toilet Bleach
萬潔靈潔廁漂

500ml
• 162 0016

UNIT Bottle 12



Kao Bleach
花王漂白水

1500ml
• 162 0012

UNIT Bottle 8



Toilet Duck Heay Duty Liquid Cleaner
潔廁得

750ml
• 162 0014

UNIT Bottle 12



Aerosol Dispenser
空氣清新機

- clock and LCD panel
- Operated by 2 AA cell battery (no included)
- 時鐘及LCD顯示屏
- 使用2顆AA電池(不包電池)

AD-008
D85 x W95 x H235mm

• 162 4057

UNIT Pc



Metered Aerosol Refill
空氣清新劑

- 300ml
- 花香味
• 162 4058001
- 薑花味
• 162 4058012
- 青檸味
• 162 4058014

UNIT Bottle





3M™ 573 General Purpose Cleaning Foam
3M™ 爽潔清潔泡

15oz (425g)
• 012 1007

UNIT Can 12



Funchem Liquid Hand Soap
護理專用洗手皂液

- pH 5 -7 neutral in nature.
- Foam rich and moderate viscosity (2500-3500 cPs) commercial pack in bottle.
- Germicidal kills germ as it cleans. Each drop of liquid soap ensures 100% hygienic.
- Prevent risk of slip when stepping on ordinary soap made up in cakes.
- 酸鹼度為 pH 5-7
- 不含非水溶劑或陽離子洗滌劑
- 泡沫豐富且中等粘度 (2500-3500 cPs) 的包裝
- 殺菌劑在清潔時殺死細菌, 可確保 100% 衛生
- 可以防止滑倒當踩在糕狀的肥皂時

500ml
• 162 0149

UNIT Bottle 12 NEW



Walch Foaming Handwashing Refreshing
威露士泡沫洗手液

300ml

• 162 0092

UNIT Bottle 12



02

Polyclean Anti Bacterial Liquid Hand Soap
保潔麗花香抗菌洗手液

1 Gallon
• 162 0067

UNIT Bottle 4



Polysoft 3in1 Anti Bacterial Liquid Hand Soap
保柔抗菌洗手液

500ml, Green

• 162 0052045

500ml, Red

• 162 0052075

1L (公升), Green

• 162 0072045

UNIT Bottle 12



Dettol Antibacterial Hand Soap
滴露健康抗菌洗手液

500ml

• 162 0077

UNIT Bottle 12



More Detergent Dishwashing Liquid
萬潔靈清亮洗潔精

1000ml, 原味
• 162 0055

UNIT Bottle 12



Magiclean Glass Cleaner
萬潔靈玻璃清潔液

500ml

• 162 0076

UNIT Bottle 24



Dettol Disinfectant Spray
滴露消毒噴霧

450ml

• 162 4014

UNIT Bottle 14



AirWick Air Freshener
喜詩空氣清新劑

300ml, Sparkling Citrus 檸檬
• 162 4003001

UNIT Bottle 12



Glade Active Carbon Lemon
佳麗消臭芳香座 - 檸檬

200g

• 162 4025

UNIT Pc 12



Kao Kitchen Bleach
花王廚房漂潔液

600ml

• 162 0005

UNIT Bottle 12



Polyclean Glass Cleaner
美國配方玻璃清潔液

533ml
• 162 0153

UNIT Bottle 12



Magiclean Trigger (Green)
萬潔靈廚房清潔劑

500ml

• 162 0001

UNIT Bottle 12



Johnson Pledge
碧麗珠檸檬香味噴蠟

330ml

• 162 1013

UNIT Bottle 12



衛生及保健用品

Hygiene & Healthcare

02

衛生及保健用品
Hygiene & Healthcare

Polyclean Liquid Detergent
保潔麗洗潔精

Polyclean Crystal Natural
Liquid Detergent
保潔麗晶亮青檸洗潔精
1000ml, 原味

- 162 1075
UNIT Bottle 12
- 1 Gallon
- 162 1254
UNIT Bottle 4



Cif Powerful Cream Cleaner
潔而亮特強去污液

500ml
Lemon

- 162 1011
UNIT Bottle 16
- Original
- 162 1116
UNIT Bottle 12



AXE Lemon Liquid Detergent
斧頭牌檸檬洗潔精

900ml

- 162 1043
UNIT Bottle 18
- 1.3kg
Pump 泵裝
- 162 1088
Pump Refill 泵裝用補充裝
- 162 1129
UNIT Bottle 12



Kao Wonderful Detergent Washing Liquid
花王萬滌洗潔精

1000ml, 原味
• 162 0006
600ml, Lemon 檸檬

- 162 0011
UNIT Bottle 10



Scrub Sponge
海綿百潔布

UNIT Pack



162 1370 162 1144 162 1062 162 1092 162 1168001 162 1335 160 0110 162 1015

Code	Description 說明	Model 型號	Size (mm) 尺寸	Packing
162 1370	Scotch-Brite Scrub Dots Scrub Sponge - Delicate Duty Non-scratch	SD31-2	---	2pcs/Pack 12
162 1335	Scotch-Brite Metallic Spiral Ball	220HK	20g	2pcs/Pack ---
162 1144	Scotch-Brite All Duty Scrub Sponge	420HK	---	4pcs/Pack ---
162 1062	Scotch-Brite Heavy Duty Scrub Sponge	325HK	85 x 65 x 30	6pcs/Pack ---
162 1092	Scotch-Brite Heavy Duty Absorbent Scrub Sponge	425HK	115 x 70 x 20	1pcs/Pack 12
162 1168001	Scotch-Brite Delicate Duty Scrub Sponge	435HK	---	1pcs/Pack 12
160 0110	Scotch-Brite Scour Pad	104HK+1	100 x 150	5pcs/Pack 6
162 1015	Scour Pad	---	---	3pcs/Pack ---

Scotch-Brite Wipe
思高萬用布

UNIT Pack



162 1073 162 1336 162 1143 162 1257

Code	Description 說明	Model 型號	Size 尺寸	Packing
162 1336	Scotch-Brite All Purpose Anti-bacterial Wipe	0070HK	300 x 600mm	5pcs/Pack ---
162 1073	Scotch-Brite® 0060HK Household Wipe	0600HK	300 x 320mm	2pcs/Pack ---
162 1143	Scotch-Brite High performance Wipe	0030HK	300 x 320mm	3pcs/Pack 24
162 1257	Scotch-Brite Microfiber Cleaning Wipes	0037-3HK+1	300 x 300mm	4pcs/Pack 24





Doctor Clean ES-800 Touchless Dispenser
紅外線免觸式掛牆洗手機

- Infrared technology, 4 x 'C' batteries(not included)
- Over 10,000+ dispenses per battery cycle
- Convenient, reliable technology; Eliminates cross-contamination
- 紅外線技術, 使用4粒C電池(不包括電池), 可連續操作10,000次或以上
- 方便、可靠的技術, 能有效消除交叉污染

For Spray Refill pad 消毒酒精噴霧器包用

• 162 0038



Refill

• 162 0039

UNIT Box



Doctor Clean ES-800B Touchless Dispenser
紅外線免觸式掛牆洗手機

- Infrared technology, 4 x 'C' batteries(not included)
- Over 10,000+ dispenses per battery cycle
- Convenient, reliable technology; Eliminates cross-contamination
- 紅外線技術, 使用4粒C電池(不包括電池), 可連續操作10,000次或以上
- 方便、可靠的技術, 能有效消除交叉污染

For Gel 消毒酒精啫喱用

• 162 0229



02

Metallic Stand

金屬座地支架

W14cm x H50cm + base dia 32cm + total high 90-165cm

• 162 0261

UNIT Box



Acrylic Desktop Stand

亞加力座枱支架

W13cm x H50 x D20cm

• 162 0234

UNIT Box

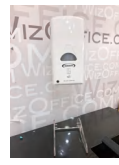

Refill

Gel

• 162 0210

UNIT Bottle



SARAYA

Saraya Toilet Seat Cleaner Dispenser (450ml)
衛生間廁板消毒器

- Our sanitising sprays are 99.99% effective against common bacteria, work very rapidly and even contain built-in moisturisers
- Highly efficient against washroom bacteria
- The amount of chemical left can easily be checked thanks to the transparent window on the side of the product
- 雅柏消毒酒精有效殺死99.99%常見細菌
- 對洗手間常見的細菌效力特強
- 側窗設計, 方便檢查酒精餘量

SC-460

D80 x W100 x H230mm

• 162 0157

UNIT Pc



Refill Alcohol

• 162 0156

Non-Alcohol

• 162 1085

UNIT bottle

Ref to Page 27



K9 Pro Palm Infrared Thermometer built-in No-touch Sanitizer Dispenser with desktop stand
K9 Pro 自動消毒液+手掌測溫儀連座台架

- Palm measuring
- Fast measurement in 0.1 second, °C and °F convertible, bi sound report the measuring result with LED light
- Sound guides to a proper measuring position, Wide measuring range, Fever alert
- 手掌測溫同時噴射搓手液·0.1秒可讀取溫度, 攝氏或華氏之溫度顯示, 螢光顯示方便閱讀
- 儲存30個記憶
- 發燒警示
- 大容量液體樽可存1000ml (搓手液或皂液)
- USB Type-C 電
- Palm 手掌式
- 30 recent records
- 30個記憶

• 162 2053

UNIT Pc



Refill Alcohol

• 162 0019

UNIT Bottle

Non-Alcohol

• 162 1085

UNIT Bottle



SARAYA

Saraya No Touch Sanitizing Dispenser
紅外線免觸式消毒洗手機

- Touchless, Suitable for hand spray or gel refill with Wall mounted or stand on
- GUD-500-PHJ: 4 x 2A batteries(not included)
- GUD-1000: 4 x D batteries(not included)
- 免接觸洗手機, 可以配合消毒酒精或消毒啫喱洗手液使用, 可掛牆或座檯兩用
- GUD-500-PHJ: 4粒 2A電池
- GUD-1000: 4粒 D電池
- GUD-500-PHJ (500ml)
- D103 x W113 x H225mm
- 162 0109
- GUD-1000 (1000ml)
- D101 x W147 x H280mm
- 162 0107001

UNIT Pc



Refill Alcohol

• 162 0019

UNIT Bottle

Non-Alcohol

• 162 1085

UNIT Bottle



GUD-500-PHJ



GUD-1000c

SARAYA

Saraya GMD-500F Hand Foam Soap Dispenser
泡沫洗手液器

- 33% save water control
- Bottled water containing 500ml of volume; Ability to use it about 500 times
- 環保節水比普通皂液機節水33%以上
- 500毫升大容量, 使用次數高達500次

• 162 0097

UNIT Pc



Refill 洗手液

• 162 0098

UNIT Bottle



02

Hygiene & Healthcare 衛生及保健用品



Scotch-Brite™ All Purpose Gloves
思高™ 多用途手套

10pcs/Pack
450D
Free Size
• 162 1071

UNIT Pack 12



Scotch-Brite™ Heavy Duty Flocked Gloves,
思高™ 高級絨裡手套

492
Small
• 162 1072001
Medium
• 162 1072002
Large
• 162 1072003

UNIT Pair 12



Marigold Plastic Housegloves
菊花牌絨裡膠手套

Small
• 160 0018
Medium
• 160 0019
Large
• 160 0023

UNIT Pair



Black Plastic Gloves
黑膠手套

Small
• 162 1006
Medium
• 162 1005
Large
• 162 1004

UNIT Pair



Cancare PEGloves™ Disposable Glove
加護™ 一次性方便手套

100pcs/Box
Medium
• 162 1265

UNIT Box



Cancare™ NitrIGloves™ Examination Gloves
加護™ 丁腈手套(無粉)

100pcs/Box
Small (6 1/2 - 7)
• 162 1341
Medium (7 1/2 - 8)
• 162 1342
Large (8 1/2 - 9)
• 162 1343

UNIT Box



NS Nitrile Glove
丁腈手套

NS-NITRILE, 100pcs/Box
Small
• 162 1460001
Medium
• 162 1460002
Large
• 162 1460003

UNIT Box NEW



NS Vinyl Glove (PVC)
乙烯基手套

NS-VINLY, 100pcs/Box
Small
• 162 1459001
Medium
• 162 1459002
Large
• 162 1459003

UNIT Box NEW



NS Latex Glove
乳膠手套

NS-LATEX, 100pcs/Box
Small
• 162 1461001
Medium
• 162 1461002
Large
• 162 1461003

UNIT Box NEW



HEALTH CARE 保健產品



Cancare ThermoCheck™ Duo Infrared
Forehead & Ear Thermometer
加護™ 紅外線額耳溫度計

- Fast measurement in 1 second, °C and °F convertible, Voice report the measuring result / time and room temperature in English, LED light
- Sound guides to a proper measuring position, Wide measuring range, Fever alert
- 一秒可讀取溫度, 攝氏或華氏之溫度顯示, 螢光顯示方便閱讀
- 儲存30個記憶連日期及次序顯示
- 特寬量度範圍, 發燒警示

Forehead and Ear(The probe must adhere to the forehead while measuring) 額耳式(量度額溫時需緊貼額頭)

30 recent records 30個記憶

• 162 2014

UNIT Pc



K3 Pro Infrared Thermometer with Stand
K3 Pro 自動人體測溫儀連腳架

- Forehead and palm measuring modes(1-10cm)
- Fast measurement in 0.1 second, °C and °F convertible, Voice report the measuring result / time and room temperature in English, LED light
- Sound guides to a proper measuring position, Wide measuring range, Fever alert
- 額頭及耳道兩種測溫模式(量度額溫時需緊貼額頭)
- 一秒可讀取溫度, 攝氏或華氏之溫度顯示, 螢光顯示方便閱讀
- 儲存30個記憶連日期及次序顯示
- 特寬量度範圍, 發燒警示
- AA x 3粒 或 USB Type-C 電

Forehead and Palm 額掌式

30 recent records 30個記憶

• 162 2051

UNIT Pc NEW



U-Shape Foldable Acrylic Sneeze Guard
U型亞加力透明隔板

- Assembly with mounting tape
- 採用納米貼安裝
- 10 sets/carton
- Front: W50 x H50cm x 1pc,
- Side: W35 x H50cm x 2pcs

• 161 6065001

UNIT carton

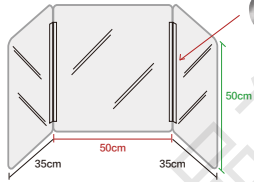

Cross Acrylic Sneeze Guard
十字型亞加力透明隔板

120 x 60cm + 60 x 60cm

• 161 6102

UNIT set

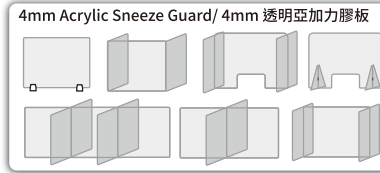
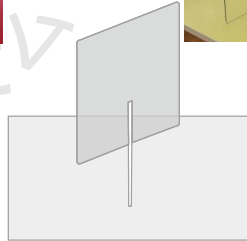

Double Side Clear Mounting Tape
雙面透明納米貼

Thickness 厚度: 1mm>30mm x 3m

• 000 2079

UNIT roll



Acrylic Stand for Sneeze Guard
亞加力透明膠腳座

- Crystal surface
- 透明度高
- L15 x D10 x H6cm

• 161 6086

L10 x D6 x H6cm

• 161 6091

UNIT Pc



Plastic White Stand for Sneeze Guard
白色三角橫向腳座

- Economy
- 經濟好用
- L14 x D6.5 x H4cm

Plastic 膠腳座

• 161 6103

L15 x D6.5 x H6.2cm

Metallic 金屬腳座

• 161 6110

UNIT Pc

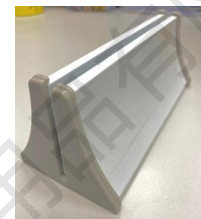

Acrylic Sneeze Guard
亞加力透明隔板

- Optional for stands
- 可另配腳座
- 10 pcs/carton
- 50 x 60cm

• 161 6092

40 x 50cm

• 161 6101

UNIT carton

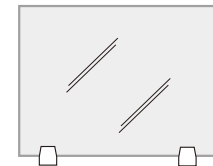
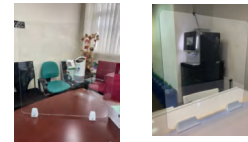

Medical Safety Goggles
醫護用護目鏡

- Fully enclosed
- High transparency
- anti-fog, anti-impact, anti-drop and dust

- 全封閉式
- 透明度高
- 防霧、防飛沫、防沙塵

JF-Y001C

• 162 1414

UNIT Pair NEW



Anti-fog Protective Goggles
護目鏡

- Fully enclosed
- High transparency
- anti-fog, anti-impact, anti-drop and dust

- 全封閉式
- 透明度高
- 防霧、防飛沫、防沙塵

JF-Y001A

• 162 1415

UNIT Pair NEW



Protective Goggles
護目鏡

- High transparency
- anti-fog, anti-impact, anti-drop and dust

- 透明度高
- 防霧、防飛沫、防沙塵

JF-Y003

• 162 1416

UNIT Pair NEW



SELLERY Safety Spectacle
護目鏡

- Wide angle vision
- 特闊可視角度
- 39-201

• 162 1146

UNIT Pair



3M 3M 1110 Foam Ear Plugs w/String
100's

3M™ 1110 即棄式有繩耳塞

100 pairs/Box

• 012 2002

UNIT Box



Disposable Face Shield
一片式面罩

- High transparency
- 透明度高

• 161 6053

UNIT Pc NEW



02

衛生及保健用品

Hygiene & Healthcare



WIPAS 高清图超透明口罩

超透
マスク



自信

舒適

美觀



TRANSPARENT MASK

透明口罩展開尺寸

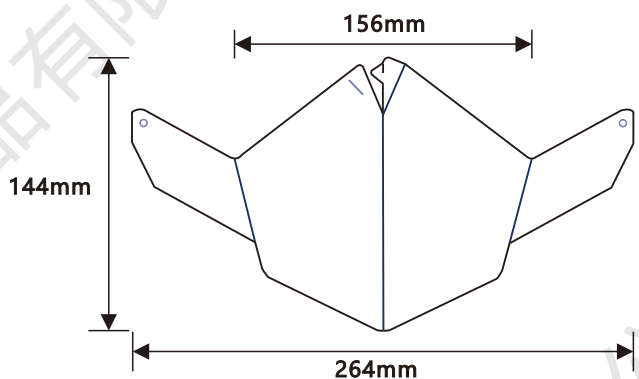

調節鬆緊 不勒耳仔

出席場合

展露笑容 形象滿分

*此產品不具備細菌防護功能，只具備阻隔功能。

One-piece Protecting Clothing(Gloves and foot covers not included)

連體式防護服 (不含手套、腳套)

- 材質：PP+PE 覆膜無紡布
- 尺碼：S/M/L/XL/2XL/3XL
- 顏色：白色+藍色條
- 隔離防菌、透氣性好、防液體飛沫、阻隔性強、消毒後可重複使用
- 供臨床醫務人員在工作時接觸到的具有潛在感染性的患者血液、體液、分泌物等提供阻隔、防護作用。
- 適用於醫療機構門診、病房、實驗室



3M 3M 8210 (N95) Mist Respirator 20s
3M N95 口罩

- Have US NIOSH N95 Standard, dust filtration efficiency of 95% or more
- 符合美國NIOSH N95標準，對粉塵過濾效率達 20pcs/Box

• 011 6005

UNIT Box 8



Protective shoe cover
防護鞋套

- 材質：PE膜無紡布
- 規格：43cm*42cm
- 顏色：白色+藍色條
- 隔離防菌、透氣性好、防液體飛沫、阻隔性強
- 鬆緊收口 密合性更好 彈性收口 穿戴舒適 阻隔性好
- 供臨床醫務人員在工作時接觸到的具有潛在感染性的患者血液、體液、分泌物等提供阻隔、防護作用。



NEW 011 6069



NEW 011 6064



011 6015



161 6016

Code	Description	User>使用者	Purpose用途	Mask size 口罩尺寸	Ply 層數	Individual Pack 獨立包裝	Packing	Carton
011 6015	3M H1820HK-M5 Earloop Mask 醫用口罩	Adult 成人	醫用口罩	9 x 17.7cm	3	---	5/box	8
161 6064	Advanced Disposable Face Mask 防護口罩	Adult 成人	醫用口罩	17.5 x 9.5 cm	3	✓	50/box	40
161 6069	Advanced Disposable Face Mask 防護口罩	Child 小童	醫用口罩	14 x 8.5 cm	3	✓	50/box	40
161 6016	Cancare PaperMask™ Paper Face Mask 加護紙口罩	Free 共用	醫用口罩	---	2	---	100/box	20

Disposable Protective Isolation Gown
綁繩保護衣

- 無紡布
- 大碼
- 162 1425

UNIT Pc NEW



SARAYA

Saraya ALPET EST No Rinse
Spray (Alcohol)
雅柏消毒酒精

- Japan formula, Contains 58% Alcohol, pH range 6.5-7.5.
- No dilution required, Can be used on culinary products
- 日本特製配方，含酒精成份58%，pH值6.5-7.5
- 不需稀釋，可用於餐具上作消毒用途

• 162 0019

UNIT Bottle 4

SARAYA

Saraya 504 Toilet Seat Sanitizer
雅柏廁板消毒液

- Benzalkonium as main sanitizing ingredient
- Wet the tissue paper with the sanitizer and then wipe the toilet seat
- 以笨扎氯銨為主要成分的殺菌劑
- 用紙巾沾上消毒劑可直接擦拭廁板消毒

5 litre

• 162 0156

UNIT Bottle 3



Prevention of Influenza Be hygienic: wash hands frequently; cover cough and sneezes; keep the environment clean and maintain good ventilation; avoid visiting crowded or poorly-ventilated places. Be responsible: if influenza-like symptoms develop, put on a mask and seek medical attention as soon as possible
預防流感: 加強衛生: 經常洗手, 咳嗽和打噴嚏時遮掩口鼻。保持環境衛生和空氣流通。避免前往人多擠迫、空氣不流通的地方。顧己及人: 若出現流感樣病徵, 就應該立即佩戴口罩及盡早求醫。

02

衛生及保健用品
Hygiene & Healthcare

Saraya Foaming Hand Soap
泡沫保濕洗手液

- Hand soap rapid drying and a smooth clean feel
- Extra moisturizers care for your skin with each application
- 洗手同時可以起到保濕作用；泡沫容易沖走，不會殘留於雙手；對皮膚溫和，不會出現皮膚乾燥的情況

Apple Fragrance, 5 Litre

• 162 0098

UNIT Bottle 3



Alcohol Refill for ES-800
消毒酒精包

- With 75% alcohol. Kills 99.9% of all hand born disease on contact and will not dry or crack the skin. It also has moisturizers in the solution to soften the hands and makes glove donning much easier.
- 含75%酒精成份。能有效殺死99.9%的細菌，也不會讓雙手乾燥或爆裂。它的保濕成份能使皮膚柔軟，容易穿戴手套。

800ml Spray

• 162 0039

UNIT Pad 6



Polyclean Disinfectant Hand Spray
保潔麗免過水抗菌噴霧液

- Anti-bacterial effectiveness against staphylococcus aureus, Escherichia coli, Pseudomonas aeruginosa and Klebsiella pneumoniae. ; 1 gallon.
- 美國配方,含PF消毒因子,抗菌殺菌, HKSTC檢定報告中能殺除99.99%接種的金黃葡萄球菌、大腸桿菌、假單胞綠膿桿菌、肺炎克雷伯氏菌等), 拼加添護膚營養成份, 含薰衣草香味。 ; 1加侖

1 gallon

UNIT Bottle 12



Cancare Alcohol Gel 600ml
加護™ 消毒酒精啫喱

- Saturated with 70% Ethyl Alcohol, Rinse free, Moisturising
- 含70% Ethyl Alcohol ; 免過水、保濕、滋潤

600ml

• 162 0106

50ml

• 162 0177 NEW

UNIT Bottle 12



Aseptioman Forte
德國醫用酒精搓手液

Dr. Schumacher

- WHO 1 formula
- 85% Ethanol
- Perfume-free, especially skin-caring with glycerine and moisturizer
- Surgical hand disinfection in 1.5 minutes
- WHO 1 世衛配方1
- 85% 乙醇酒精
- 不含香料, 含護膚油
- 1.5分鐘內可進行外科手術

100ml

• 162 0183 10 NEW

500ml

• 162 0184 20 NEW

1L

• 162 0196 10 NEW

UNIT Bottle Germany



Aseptioman Gel
德國醫用酒精搓手啫喱

Dr. Schumacher

- WHO 1 formula
- 85% Ethanol
- Perfume-free, especially skin-caring with glycerine and moisturizer
- Surgical hand disinfection in 1.5 minutes
- WHO 1 世衛配方1
- 85% 乙醇酒精
- 不含香料, 含護膚油
- 1.5分鐘內可進行外科手術

500ml

• 162 0114

UNIT Bottle 20 Germany NEW



DoctorClean Alcohol Hand Sanitizer Gel
免過水啫喱洗手液

- 62% Ethyl alcohol.
- Kills 99.99 of germs
- Moisturising
- 含62%消毒酒精
- 殺滅99.99%病菌
- 防過水, 保濕

5L

• 162 0210

1000ml

• 162 0209

UNIT Bottle NEW



Dr. Cool Hand Sanitizer Gel
免過水啫喱洗手液

- Ingredient: Ethyl Alcohol, Water, Glycerin, Propylene Glycol, Poly(arylic acid), Triethanclamine, Kills 99.99% of common germs and leaves hand clean without water or towels.

- 含乙醇酒精、水、甘油、丙二醇、聚芳酸、三乙胺成份, 證書: FDA, ISO9001及可殺死99.99%細菌。

75% Ethyl Alcohol, 500ml Silicon Holder for 30ml

• 162 0228

65% Ethyl Alcohol, 30ml

• 162 0227

UNIT Bottle



30ml

50ml

100ml



AlcoholRub™ World Alcohol Liquid
加護™ 酒精消毒液

- 80% Ethyl alcohol, Rinse free. Moisturising.
- 含80%消毒酒精
- 防過水, 保濕

600ml

• 162 0166

UNIT Bottle 12



Saraya Alcohol-based Hand Rub
雅柏酒精搓手液

- 氣味清淡, 不含強烈氣味酒精味。
- 用後不黏手

with Pump 連噴咀, 500ml

• 162 0167

UNIT Bottle 10

100ml

• 162 0138

UNIT Bottle 20



3M™ Avagard™ Foaming Instant Hand Antiseptic
3M™ Avagard™ 即時快速免過水消毒搓手泡沫

- 70% v/v ethyl alcohol
- Rapidly kill a wide bacteria spectrum
- Killing 99% germs within 15 second
- FDA approved
- Special formula won't harm to skin
- Rinse-Free formula
- 含70% Ethyl Alcohol
- 快速且廣泛殺滅細菌的專業配方, 方便之選
- 可以在15秒內殺死99%以上的病菌
- 符合美國FDA標準規範
- 含特殊潤膚配方, 不損皮膚
- 用後免沖水, 使用方便

9321A 500ml

• 012 0012

UNIT Bottle



Side Pull Paper Hand Roll Towel Dispenser
側拉抹手紙機

L275 x W240 x H345mm
HRT-393
● 759 9012

UNIT Pc



Autocut Hand Roll Towel Dispenser
自動切紙抹手紙機

L300 x W237 x H410mm
CD8088A
● 759 9013

UNIT Pc



M-Fold Paper Towel Dispenser
"M"型摺疊式抹手紙器

L248 x W100 x H348 mm
CD-8035A, White
● 759 9001085

UNIT Pc



Middle-pull (Centre Pull) Dispenser
中間抽取式衛生紙架

D231 x W263 x H326mm
CD-8020A
White Cover
● 759 9011085
CD-8020B
Smoky Cover
● 759 9011035

UNIT Pc



Jumbo White Bathroom Dispenser
大卷衛生紙架

D130 x W271 x H281mm
CD-8002A, Single (單卷)
White Cover
● 759 9009085
CD-8002B, Single (單卷)
Smoky Cover
● 759 9009035

UNIT Pc



759 9009085



759 9009035

High Q Hand Roll Paper Towel
前滾式手紙

MP331, 1200g (Virgin)
● 755 7056

UNIT Ctn



Vinda M-Fold Paper Towel
"M"型摺疊式抹手紙

- Ideal for use in standard hand towel dispensers, M-folded system allows dispensing 1 sheet at a time there by reducing waste.
- 適用於一般紙巾盒, "M"型摺疊方式, 可控制取出量; 100%木漿製造

250pcs/Pack

● 755 7007

UNIT Pack



AK M-Fold Paper Towel
抹手紙

- Hong Kong Safety Certificate, ISO9001, 14001 Certified, 100% Virgin Pulp
- ISO9001, ISO14001. 100%原木藥紙 Y914L

250pcs/Pack

230 x 230mm

● 755 7045

UNIT Ctn

M-Fold Paper Towel (Recycle)
環保抹手紙

- Hong Kong Safety Certificate, ISO9001, 14001 Certified

200pcs/Pack

● 755 7028

UNIT Ctn



High Q M-pull Paper Towel
中間抽取式手紙

MP650C,
1250g (Virgin)
● 755 7048

UNIT Ctn

MP611,
1250g (Recycle)
● 755 7054

UNIT Ctn



Vinda Jumbo White Bathroom Tissue
特大衛生紙卷

9.5cm x 24cm, 800g
● 165 7003

UNIT Roll

High Q Jumbo White Bathroom
2-ply Tissue (12 rolls)
特大衛生紙卷(12卷)

3 rolls x 4 Packs
2099, 9.5cm x 24cm, 800g

● 755 7050

UNIT Ctn



02

衛生及保健用品

Hygiene & Healthcare

02

Hygiene & Healthcare
衛生及保健用品



Vinda Tissue Roll
維達衛生紙卷

- Soft and tender. Wooden Pulp.
- 柔軟堅韌，耐用持久純木漿紙。
- 10rolls/Pack
- 2-ply, 120g

UNIT Pack 12



2-ply, 重量: 120g
• 755 7069



3-ply, 重量: 140g
• 755 7070



Vinda Tissue Roll
維達衛生紙卷

- Soft and tender. Wooden Pulp.
- 柔軟堅韌，耐用持久。純木漿紙。
- 藍色包裝, 3-ply, 38m, 180g
- 755 7016

UNIT Pack 12



C&S 3-ply Ultra Tissue Roll
潔柔衛生紙(橙包裝)

- 3- ply 100% Pulp
- 三層 100% 原木漿紙。
- 10rolls/Pack, 185g
- 755 7034

UNIT Pack 10



Virjoy Economy Tissue Roll
3-ply 100% Pulp
唯潔雅衛生紙卷

- 3-ply 100% Pulp
- 三层100%原木漿紙。
- 10rolls/Pack, 180g

*
UNIT Pack 10



Virjoy (Yellow) Tissue Roll 3-ply
唯潔雅衛生紙卷

- 28m / 270 sheets
- 3- ply 100% Virgin Pulp
- 270張
- 三層 100% 原木漿紙
- 10rolls/Pack, 135g
- 755 7022

UNIT Pack 10



Virjoy (Silver) Tissue Roll 3-ply
唯潔雅衛生紙卷

- 3- ply 100% Pulp
- 三層 100% 原木漿紙。
- 10rolls/Pack, 115g
- 755 7029

UNIT Pack 10



755 7051



755 7032



785 7002



785 7008



755 7003



755 7046

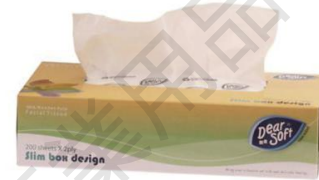

755 7066

Code	Brand 品牌	Sheets/Box 每盒數量	ply/sheet 每張層數	Box/Pack 每排數量	Selling Unit	Packing
755 7051	Vinda 維達	120	2-ply	6	Box	60
755 7032	Tempo 得寶	90	3-ply	5	Pack	20
785 7002	Scott Facial 絲潔高級	120	2-ply	5	Pack	50
785 7008	Scott 絲潔	200	2-ply	5	Box	50
755 7003	White box 白盒	100	2-ply	---	Box	50
755 7046	Vinda Pack 維達包裝	180	2-ply	6	Pack	12
755 7066	Dear Soft 親柔	200	2-ply	---	Box	60



Vinda Smart Kitchen Towel Roll
維達抹手紙

9", 2-ply, 4rolls/Pack
• 162 1435

UNIT Pack 60



Napkin Dispense
膠餐紙巾盒

L110 x W110 x H80mm
• 169 9251

UNIT Pc



Paper Napkin
抽取式餐紙

175 x 105mm
100pcs/Pack
• 755 7049

UNIT Pack



Napkin Paper
方形餐巾

2層四摺,
250pcs/Pack, 24 x 24cm
• 755 7020

UNIT Pack 20



02



Dettol Anti-Bacterial Wet Wipes
滴露殺菌濕紙巾

50sheets/Pack
• 165 7010

UNIT Pack 24



Dettol Disinfecting Surface Wipes
滴露消毒清潔濕紙巾

20 x 18 cm
80sheets/Bottle
Original 原味
• 165 7011
Lemon 檸檬味
• 165 7018

UNIT Pack 24



原味

檸檬味



Cancare AlcoholPrep™
加護™ 消毒酒精棉

• Individual Pack
• 70% Isopropyl Alcohol,
65 x 30mm
200pcs/Box
• 160 0328

UNIT Box 40



Cancare Alcohol Wipes™
加護™ 消毒酒精濕紙巾

• Individual Pack, 75% Alcohol
• 200 x 150mm
30pcs/Box
• 160 0326

UNIT Box 24



Scotch-Brite™ General Purpose
Disinfecting Wipes
思高牌家居潔淨消毒抹布

17 x 20cm
857HK, 40pcs/Bottle
• 012 1035
857HK-85, 85pcs/Bottle
• 012 1036

UNIT Bottle



Clorox Disinfecting Wipes
高樂氏消毒濕紙巾

105sheets/Bottle
• 162 1218001
35sheets/Bottle
• 162 1087

UNIT Bottle



Walch Antibacterial Wet Wipes
威露士消毒濕紙巾

40pcs/Bottle
• 162 0129

UNIT Bottle 12

10pcs/Pack
• 162 0158

UNIT Pack 48



Green Shield 75% Alcohol Towel
綠盾酒精消毒濕紙巾

• 75% alcohol, Certification of FDA ISO13485, ISO9001, MSDS,
Individual Pack, Made in China.
• 75%酒精配方
• 獨立包裝
• 可用於皮膚、傷口周圍、注射前消毒、
鍵盤、手機、經常觸摸物品、馬桶坐墊
等使用前消毒
50pcs/Pack
• 165 7009

UNIT Pack 50 China



衛生及保健用品

Hygiene & Healthcare

Dr. COOL

免過水酒精搓手啫喱

快速消毒

呵護雙手

有效殺菌

另配

30ml專用
矽膠套

30ml連專用
矽膠套



65%酒精成份

70%酒精成份

75%酒精成份

AIR PURIFIER 空氣清新機

3M 3M Room Air Purifier 3M空氣淨化器

UNIT Pc NEW



FAPHK-C01WA-A



FAPHK-T02WA-F1



FAPHK-T03WA-F3

產品型號	FAPHK-C01WA-A	FAPHK-T02WA-F1	FAPHK-T03WA-F3
貨品編號	017 5021	017 5020	017 5019
外觀顏色	白色	白色	白色
使用面積	245ft ²	413ft ²	581ft ²
CADR (潔淨風量值)	190CMH	320CMH	450CMH
除病毒及病菌效能	>99%#	>99%#	>99%#
產品尺寸 (深 x 闊 x 高)	284 x 216 x 392mm	257 x 250 x 634mm	310 x 300 x 721mm
淨重 (±5%)	11.5kg	5.8kg	3.5kg
保養期	1年自攜保養	1年自攜保養	1年自攜保養
純物理過濾，零臭氧			
濾網設計	濾除病毒、細菌、過敏源及顆粒物		
濾網型號	MFAF190-1P	MFAF320-1P	MFAF450-1P
濾網貨品編號	017 5022	017 5024	017 5026
濾網設計	濾除病毒、細菌、過敏源、顆粒物、異味和揮發性有機化合物VOC氣體		
濾網型號	MFAF190-ORF	MFAF320-ORF	MFAF450-ORF
濾網貨品編號	017 5023	017 5025	017 5027

3M 3M Filtrete Filter 3M靜電空氣濾網

Ultra Allergen Reduction 超效能過濾
14"x26", 9908

• 017 5017
14"x103", 9908R

• 017 5018
Mirco Allergen Reduction 高效過濾
15"x24", 9808

• 017 5010
15"x96", 9808R

• 017 5007

UNIT Pc



美國肺臟協會
健康夥伴及推薦



9908R



9808R



9908

TruSens

UV空氣淨化器能有效殺死98%的細菌** 加強守護您的健康

殺滅99.99%冠狀病毒認證

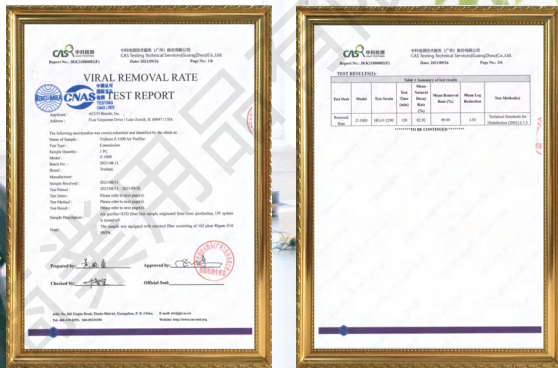

- 即時監測空氣質量
- LED顯示空氣質量指數
- 雙氣流技術
- 多層高效過濾
- UV紫外線殺菌
- 濾網更換提醒
- 自動調節風速
- 睡眠模式



先進淨化技術



SensorPod*
即時監測空氣質量



空氣質量指數顯示*
根據數據自動調節風速

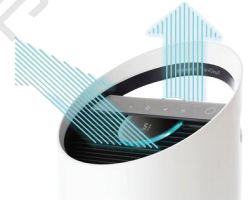

PureDirect雙氣流技術
潔淨空氣輸送效率提升高達24%

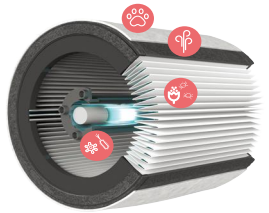

4層高品質組合濾網*
可消除小至0.3微米的污染物

潔淨空氣覆蓋範圍



Z-1000
250 sq.ft.



Z-2000
375 sq.ft.



Z-3000
750 sq.ft.

#測試報告結果證明UV燈可殺死98%的金黃葡萄球菌和綠膿桿菌 *僅限Z-2000 & Z-3000

TruSens

TruSens Air Purifier

空氣淨化器

- WASHABLE PRE-FILTER*
可清洗濾網*
- CARBON FILTER
活性碳過濾網
- HEPA FILTER
HEPA 濾網
- UV STERILIZATION
紫外線消毒燈

UltraViolet
sterilization

*Not suitable for model Z-1000
不適用於Z-1000型號
#Z-2500 and Z-3500 only
只適用於Z-2500及Z-3500型號



UVC對人體有害的臭氧
(加州CARB安全認證)

歐洲防敏研究中心
(ECARF認證)

02

Hygiene & Healthcare 衛生及保健用品

PureDirect™ Technology
雙氣流技術



Senses pollutants*
監察污染物*



Responds to your air*
為你空氣調節*



Smart app#
為你空氣調節#



3款專業濾網

配合環境需要，自行另購專業濾網

- 寵物專業濾網**
 - ✓ 捕獲高達99.97%寵物皮屑及毛髮
 - ✓ 消除一般寵物氣味
- 流感及致敏原專業濾網**
 - ✓ 捕獲高達99%致敏原
 - ✓ 捕獲H1N1病毒
- VOC除臭味專業濾網**
 - ✓ 消除烹飪和清潔異味
 - ✓ 消除VOC有機化合物異味



Model No.	型號	Z-3500	Z-3000	Z-2500	Z-2000	Z-1000
Code	貨品	217 5043	217 5010	217 5044	217 5011	217 5012
Smart App Control	Smart App 手機操控監察	✓	---	✓	---	---
SensorPod™	SensorPod™ 獨立遙距監控器	✓	---	✓	✓	---
Air Quality indicator	空氣質量指數顯示	✓	✓	✓	✓	---
PureDirect™ Technology	PureDirect™ 雙氣流技術	✓	✓	✓	✓	✓
Levels of Purification	段數	5	5	4	4	3
Room Coverage	室內覆蓋範圍	750ft²(70m²)	750ft²(70m²)	375ft²(35m²)	375ft²(35m²)	250ft²(23m²)
Auto Mode	自動模式	✓	✓	✓	✓	---
CADR	CADR	208m³/h	208m³/h	117.2m³/h	117.2m³/h	96.7m³/h
Carry Handle	把手	✓	✓	✓	✓	✓
Touch Controls	觸控	✓	✓	✓	✓	✓
Dimension (WxH)mm	體積(闊x高)mm	250 x 720	250 x 720	230 x 560	230 x 560	200 x 480
Weight (kg)	重量 (kg)	5.8	5.8	3.8	3.8	3.4
Warranty	保養	1 Year Carry On				

Standard Filter 標準濾網						
			Replace time 使用時間 (9-12hrs/day)	Z-3000 Z-3500	Z-2000 Z-2500	Z-1000
	HEPA Filter Refill	HEPA 濾網型號	12-15 months	AFHZ3000-01 (3in1)	AFHZ2000-01 (3in1)	AFHZ1000-01 (2in1)
	Code	貨品編號		217 5015	217 5014	217 5013
	Carbon Filter Refill (3 pcs/box)	活性碳濾網型號 (3片裝)	3 months	AFCZ3000-01	AFCZ2000-01	AFCZ1000-01
	Code	貨品編號		217 5018	217 5017	217 5016
	Pre-filter Refill	可清洗預過濾網型號	Depending on usage	AFPZ3000-01	AFPZ2000-01	----
	Code	貨品編號		217 5023	217 5022	----
	UV Bulb	UV-C紫外光燈型號	24-36 months	UVLZ3000-01	UVLZ2000-01	UVLZ1000-01
	Code	貨品編號		217 5021	217 5020	217 5019
Specialty Filter 專業濾網						
	Pet Filter	寵物濾網型號	12-15 months	AFHZ3000-PET01	AFHZ2000-PET01	AFHZ1000-PET01
	Code	貨品編號		217 5026	217 5025	217 5024
	Odor & VOC Filter	VOC除臭味濾網型號	12-15 months	AFHZ3000-SMK01	AFHZ2000-SMK01	AFHZ1000-SMK01
	Code	貨品編號		217 5029	217 5028	217 5027
	Allergy & Flu Filter	致敏原及流感濾網型號	12-15 months	AFHZ3000-AGY02	AFHZ2000-AGY01	AFHZ1000-AGY01
	Code	貨品編號		217 5042	217 5031	217 5030
	Pet Carbon Filter	寵物活性碳濾網型號	Depending on usage	AFHZ3000-PET01	AFHZ2000-PET01	AFHZ1000-PET01
	Code	貨品編號		217 5035	217 5034	217 5033
	Odor & VOC Carbon Filter	VOC除臭味活性碳濾網型號	Depending on usage	AFHZ3000-SMK01	AFHZ2000-SMK01	AFHZ1000-SMK01
	Code	貨品編號		217 5038	217 5037	217 5036
	Allergy & Flu Carbon Filter	致敏原及流感活性碳濾網型號	Depending on usage	AFHZ3000-AGY01	AFHZ2000-AGY01	AFHZ1000-AGY01
	Code	貨品編號		217 5041	217 5040	217 5039



TruSens 專業濾芯



寵物專業濾網

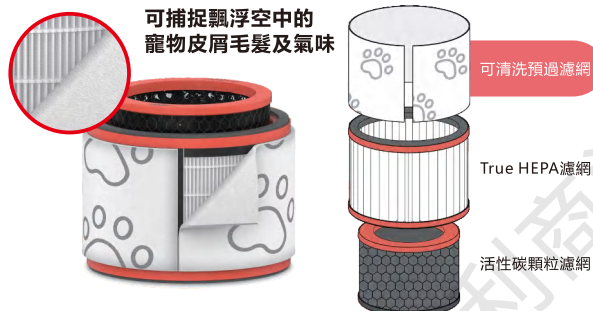

可捕捉飄浮空中的寵物皮屑毛髮及氣味

配合True HEPA濾網，能夠捕捉高達99.97%的寵物皮屑，消除常見的寵物氣味，讓你在家呼吸到更清新的空氣。

致敏源及流感專業濾網

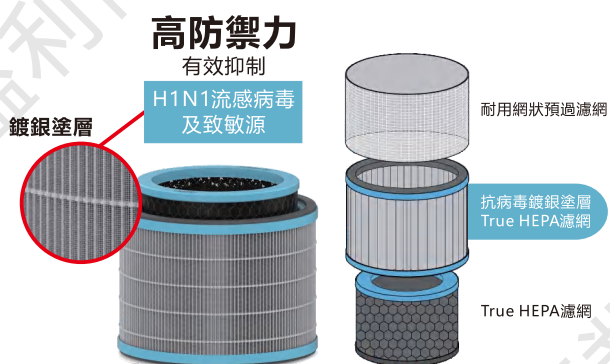

高防禦力
有效抑制
H1N1流感病毒及致敏源

鍍銀塗層

耐用網狀預過濾網

抗病毒鍍銀塗層

True HEPA濾網

True HEPA濾網



VOC除異味專業濾網



可去除VOC化合物及物件發出的異味

配合專門設計的含活性炭量較多的True HEPA濾網，能夠去除常見的烹飪和清潔時發出的異味，並能減少揮發性有機化合物。

*三款專業濾芯適用於Z-1000, Z-2000和Z-3000機型。購買時配備的是標準濾芯，非專業濾芯。若需配備專業濾芯，請與銷售人員說明。

OSALO®

Light touch calculator

OSALO ELECTRONIC TECHNOLOGY CO.,LTD

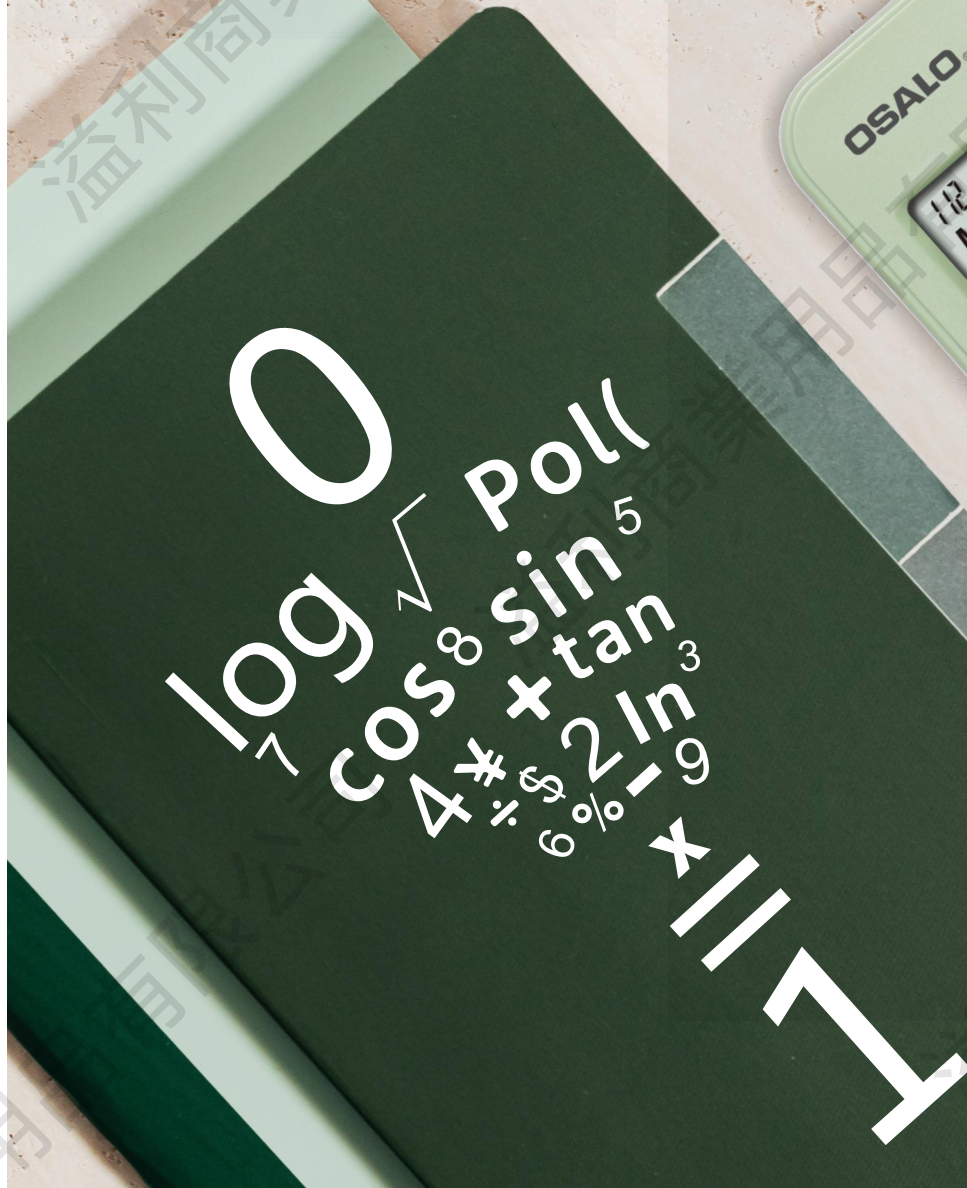
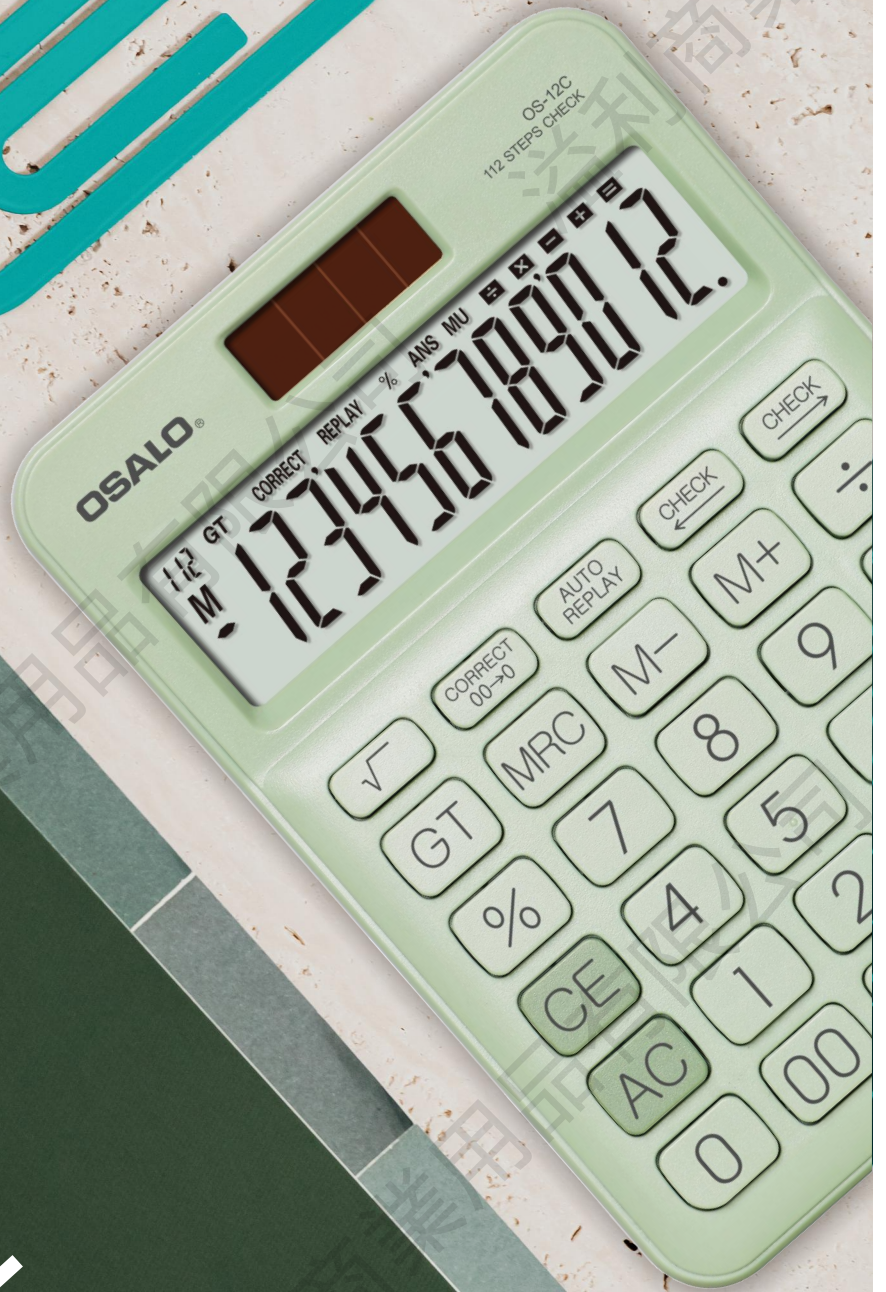

OSALO light touch calculator

Pressing the calculator doesn't need to be so hard

