

辦公室傢俱 Office Furniture

Back Support	健康背墊	159
Floor Mat	坐立地墊	160
Office Table and Chair	辦公室檯椅	160
Safety Cabinet	夾萬	167
Footrest & Step Stool	腳踏	170
Filing Cabinet	文件櫃	171
Drawing Rack	圖紙架	172
Logistics Box	物流膠箱	172
Wheel Carts	平板車	172
Trolley	手推車	173
Newspaper / Magazine Rack	報紙 / 雜誌架	174
Tools	五金工具	174
Umbrella Stand	雨傘架	175
Safety Ladder	安全工作梯	175



08

辦公室傢俱
Office Furniture

OBUSFORME®

OBUS FORME® Backrest

專業背墊

- The S-shaped polyurethane frame conforms to and supports the natural curve of your spine to promote proper sitting posture.
- An adjustable and removable lumbar pad can be used to fill in the curve in the lower back for added support.
- S型設計承托力強，保持正確坐姿。
- 可調校式及拆除式腰墊，加強下背部支撐。

Lowback 矮背墊

Size : D17.8 x W44.5 x H53.3cm

Black

• 531 8010

Blue

• 531 8010025

UNIT Pc



Highback 高背墊

Size: D17.8 x W45.1 x H77.5cm

Black

• 531 8011

Blue

• 531 8011025



Kensington

Memory Foam Back Support

專業系列背墊/坐墊

- Give your back full support with high-density, viscoelastic memory foam
- Temperature and pressure-sensitive foam molds to body shape
- Easy-to-adjust straps allow virtually universal chair fit
- Removable, washable fabric cover included
- 高密度彈性記憶棉為背部提供支撐
- 根據人體溫度和壓力記憶棉自動調整形狀
- 可調節椅背帶
- 可拆洗的布套

L82025F

Size: L16" x W12" x H16"

Black

• 871 8043

UNIT Pc



L82024F

Size: L14.5" x W13.5" x H2"

Black

• 871 8044



Kensington

Kensington Half Back Pad

背墊

- Anatomically molded, eggshell foam backrest encourages correct posture
- Supports the spine for long-lasting comfort
- Crisscross straps provide easy adjustment of pad along chair back
- Soft, washable stretch Lycra slip cover included
- 支撐脊椎，持久舒適
- 交叉帶可調節椅背上的墊子
- 柔軟、可清洗彈性 Lycra 套

L82021B

Size : D1.5" x W12.5" x H13.8"

• 871 8042

UNIT Pc



Chair Mat Carpet

有釘椅伴膠地墊

- It makes the chairs moving above the carpet smoothly
- Its pins hold the carpet tightly and not easy to slide
- Anti-slipping design
- 令椅子在地氈上滑動得更流暢
- 釘腳緊抓地氈，不會移位
- 防滑倒設計

Size: 45" x 53"

• 009 9271

Size: 46" x 60"

• 009 9420

UNIT Pc

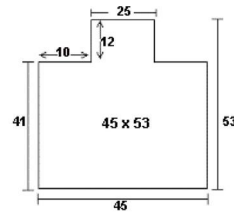

Fellowes

Fellowes FW9191301 Mesh Backrest

網紋腰背保護墊

- Molds to your body and provides maximum support with additional padded features.
- Easily attaches to any chair
- 通過保持背部曲線來減輕壓力
- 輕鬆連接任何椅子

Size : D141 x W440 x H513mm

Black

• 211 8057

UNIT Pc



Fellowes

Fellowes FW91926 Backrest

背墊

- Designed with high-density foam for shape retention and firm support
- Maintains the back's natural curve and pro-motes neutral posture
- Soft, brushed covering is removable for easy cleaning
- 高密度乳膠製造，不易變形
- 附有索帶設計，可調較高度。絨面可隨意折出清潔

Size : D102 x W330 x H305mm

Graphite Colour

• 211 8003

UNIT Pc



Foldable Backrest Cushion Chair

健康護脊坐墊

- 保持脊椎挺直，矯正坐姿> 軟墊部份可拆除清洗

Size : D360 x W380 x H280mm

Black

• 531 8124015

Grey

• 531 8124012

UNIT Pc





WIPAS Anti-Fatigue Floor Mat

防疲勞坐立地墊

- Stand in comfort with this durable floor mat
- Encourages subtle movement to prevent fatigue
- Use with any sit-stand for extra support while standing
- Beveled edges help avoid trip hazards
- No covering with other material, used newest special self-skining technology finishing with 100% PU material of the whole body (surface, core and bottom), makes the mat more durable than normal ones
- 保持雙腳舒適及靈活
- 鼓勵配合站立時的微量運動以防止整天的疲勞
- 配合任何Sit-Stand工作平台使用，可在站立時提供額外支持
- 斜邊有助於避免絆倒危險
- 本產品無其他材料覆蓋，採用最新的特殊自結皮技術，整塊墊子採用 100% PU 材料（表面、核心和底部），使這款墊子比普通墊子更耐用

L88.5 x W49.5 x H2cm

UNIT Pc



WPS-LZ601

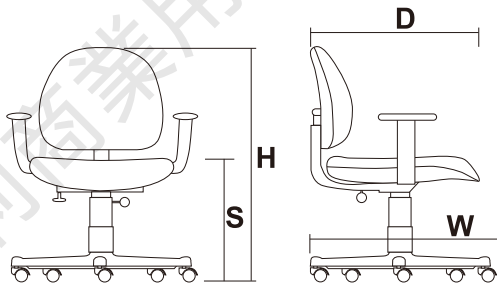

An exact colour match on this catalogue cannot be guaranteed as batch. 圖像可能與實物顏色及質料有輕微偏差，只作參考用途。

Elegant Luxus		Fabric 布料			
Black	Blue	Black	Blue	Brown	Yellow
Orange	Red	Olive	Orange	Red	Vinyl Black

Elegant Clerical Armchair

辦公室油壓扶手轉椅

U515B53D+AEU19

- Vinyl Black • 903 30380
 Black • 903 3038015
 Blue • 903 3038025
 Olive • 903 3038041
 Red • 903 3038075

W: 640mm
 D: 470mm
 S: 450 - 540mm
 H: 860 - 1020mm

※ Adjustable Arm
 ※ 升降扶手



UNIT Pc



Mesh Back Clerical Nano Armchair

辦公室網紋背油壓納米轉椅

- Waterproof fiber
 - 防水布料
- NANO-ih18k-1
 Grey • 903 3078012
 Black • 903 3078015

W: 630mm
 D: 490mm
 S: 440 - 530mm
 H: 880 - 970mm



UNIT Pc



Clerical Armchair

辦公室油壓轉椅

K-1208P
 Vinyl Black
 • 903 3089

W: 600mm
 D: 560mm
 S: 450 - 560mm
 H: 840 - 950mm



UNIT Pc



Clerical Armchair

辦公室油壓轉椅

Hody-i8
 Black
 • 903 3090

W: 620mm
 D: 560mm
 S: 480 - 540mm
 H: 970 - 1080mm

※ Adjustable Arm
 ※ 升降扶手



UNIT Pc



08

辦公室傢俱

Office Furniture

Luxus Mesh Managerial Armchair
中網背油壓轉椅

- C-2015AE
Vinyl Black ● 903 3057
Black ● 903 3057015
Blue ● 903 3057025
Red ● 903 3057075
Orange ● 903 3057055

W: 480mm
D: 480mm
S: 410 - 500mm
H: 910 - 1000mm



Elegant Mesh Managerial Armchair
中網背油壓轉椅

- M531B68A+AHU38
Black ● 903 3042015
Blue ● 903 3042025
Brown ● 903 3042035
Red ● 903 3042075

W: 500mm
D: 470mm
S: 430 - 520mm ※ Adjustable Arm
H: 1050 - 1095mm ※ 升降扶手

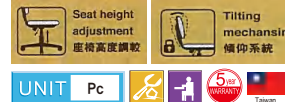

Luxus Mesh Managerial Armchair
高網背油壓轉椅

- M-55960AE
Vinyl Black ● 903 3056
Black ● 903 3056015
Blue ● 903 3056025
Red ● 903 3056075
Orange ● 903 3056055

W: 650mm
D: 500 - 550mm
S: 440 - 550mm
H: 1000 - 1110mm



Luxus Mesh Guest Armchair
中網背客轉椅

- C-20159
Vinyl Black ● 903 3055
Black ● 903 3055015
Blue ● 903 3055025
Red ● 903 3055075
Orange ● 903 3055055

W: 525mm
D: 480mm
S: 460mm
H: 940mm



Elegant Mesh Managerial Armchair
高網背油壓轉椅

- M831EA
Mesh Black
W: 520mm
D: 500mm
S: 460 - 550mm
H: 1080 - 1170mm
● 903 3069



※ Optional neckrest
※ 頸枕可另購



Luxus Mesh Armchair
網背扶手椅

- Optional accessory : Castars
 - 可另選購四向輪
- C-457A

- Vinyl Black ● 903 3070
Black ● 903 3070015
Blue ● 903 3070025
Red ● 903 3070075

W: 470mm D: 440mm
S: 440mm H: 990mm



Luxus Mesh Foldback Managerial Armchair
高網摺背油壓轉椅

- Optional foot pad
 - 可另購腳墊
- M-20250N
Blue • **903 3082025**
W : 520mm
D : 530mm
S : 430 - 520mm
H : 1130 - 1220mm



UNIT Pc



Luxus Mesh Foldback Managerial Armchair
中網摺背油壓轉椅

- Optional foot pad
 - 可另購腳墊
- M-20251N
Blue
• **903 3083025**
W : 510mm
D : 530mm
S : 430 - 520mm
H : 950 - 1040mm



UNIT Pc



08



Managerial Armchair
高背油壓轉椅

- Hoby-H401
Vinyl Black
• **903 3084**
W : 710mm
D : 600mm
S : 450 - 550mm
H : 1140 - 1240mm



UNIT Pc



Guest Armchair
中背客轉椅

- Hoby-401
Vinyl Black
• **903 3085**
W : 640mm
D : 580mm
S : 450 - 550mm
H : 960 - 1150mm



UNIT Pc



Mesh Managerial Armchair
高網背油壓轉椅

- Aeras-X1138
Black
• **903 3087**
W : 670mm
D : 490mm
S : 440 - 540mm
H : 1150 - 1320mm



UNIT Pc



Mesh Managerial Nano Armchair
高網背油壓納米轉椅

- Waterproof fiber
 - 防水布料
- NANO-ih15
Grey
• **903 3077012**
Black
• **903 3077015**
W : 670mm
D : 460mm
S : 450 - 530mm
H : 1110 - 1190mm



UNIT Pc



Managerial Armchair
豪華型油壓扶手轉椅

- CG-012T Medium Back 中背
Grey • **903 3024013**
Blue • **903 3024025**
L. Black 仿皮黑 • **903 3024015**

背墊 : W490 x H570mm
座墊 : W500 x D560mm
座墊高度 : H580mm
全椅高度 : H1190mm



UNIT Pc

- 629AG High back 高背
L. Black 仿皮黑 • **903 3025015**
Dark Grey • **903 3025013**

背墊 : W520 x H650mm
座墊 : W520 x D460mm
座墊高度 : H540mm
全椅高度 : H1140mm



UNIT Pc

Managerial Nano Armchair
中網背油壓納米轉椅

- Waterproof fiber
 - 防水布料
- NANO-ih100bk
Grey
• **903 3088**
W : 630mm
D : 500mm
S : 450 - 540mm
H : 970 - 1060mm



UNIT Pc



CG-012T



629AG

辦公室傢俱
Office Furniture

08

辦公室傢俱

Office Furniture

Elegant Lab & Workshop Chair
Elegant實驗室工作椅

W203
W : 460mm, D : 460mm
S : 420-550mm, H : 795-990mm
● 903 3051
W203X
With foot ring 連腳踏圈
W : 460mm, D : 460-475mm
S : 575-825mm, H : 975-1285mm
● 903 3066
UNIT Pc



W203

W203X

Elegant Swirval Chair with castors
轉椅連轆

B3036
座闊(W) : 310mm, 座高(SH) : 420-545mm
● 903 3059
B3136
with foot ring 連腳踏圈
座闊(W) : 310mm, 座高(SH) : 600-720mm
with foot ring
連腳踏圈
● 903 3060
UNIT Pc



B3036

B3136

Elegant Swivel Chair
學習升降轉椅

W211
座闊(W) : 360mm, 座高(SH) : 680-800mm
● 903 3071
UNIT Pc



Folding Table
摺檯

FTJS45C, D450 x W1800 x H740mm
Grey
● 009 9296012
Wooden
● 009 9296035
FTJS60C, D600 x W1800 x H740mm
Grey
● 009 9295012
Wooden
● 009 9295035
UNIT Pc



Folding Chair
摺椅

• Electricplate rack with vinyl seat
• 電鍍腳, 仿皮面
FCHH17
Black
● 009 9297015
Red
● 009 9297075
UNIT Pc



CFC Folding Chair
摺椅

• Vinyl seat
• EN 12520: 2010 + EN 1728
+ EN 1022 Certification and
safety lock
• 仿皮面
• EN 12520: 2010 + EN 1728
+ EN 1022證書及加上安全
鎖, 完全符合安全標準
W440 x D470 x H810mm
Black
● 903 3067015
Red
● 903 3067075
UNIT Pc



※可選其他顏色

Stackable High Stool
圓形高腳膠疊椅

1290, Size: D340 x W340 x H424mm
Grey
● 009 9393012
UNIT Pc



Elegant Row Chair
Elegant排椅

Cloth material
L101 ● 903 3061025
L102 ● 903 3062025
L103 ● 903 3063025
Plastic
L822 ● 903 3064035
L823 ● 903 3065035
UNIT Pc



L822



L823



L102

L103

Elegant Guest Chair
Elegant客椅

Size : D570 x W510 x BH390 +
SH450mm
D901V
● 903 3049
Armchair 扶手椅
D900V
● 903 3048
UNIT Pc



D901V

D900V

HOLLIES

ERGO ACCESSORIES

Make Better Life

HL DW-806
啫喱手腕墊



HL SL-444
鑽檯式鍵盤托



HL SL-450
夾檯式鍵盤托連活動滑鼠墊



HL SL-655
可調較腳踏



HL SL-449
鑽檯式鍵盤托連活動滑鼠墊



HL Z-654
標準腳踏



HL DW-921
啫喱手腕墊連滑鼠墊



HL SL-391H
主機承托架

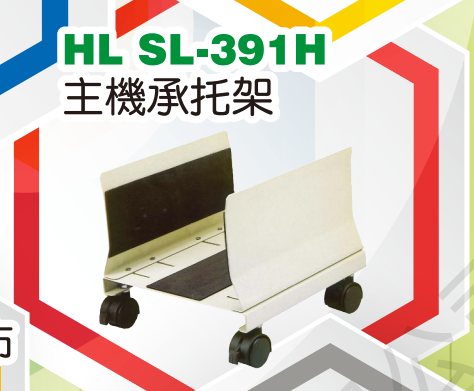

HL 001
防靜電螢幕清潔纖維布



HL C9071
手提電腦鎖連鎖匙



HL CDE-50
光碟封套(50片裝)



HL CS-250
螢幕清潔劑



HL AC-120/450
壓縮氣體除塵劑



120ml
450ml

PROFESSIONAL

電腦產品

人體工學

ERGONOMICS



人體工学製品

人間工学に基づいた製品

一鍵升降 高度自由切换
坐站相宜 舒緩腰間疲累



電動升降工作檯(坐站兩用)
WPS-GHED121D-G2

- 鋼化玻璃檯面+鋼製腳架
- 檯面升降範圍28"-47"(720-1200mm)
- 最大承重110 lbs(50kg)
- 4檔記憶高度
- 遇阻回退功能
- IP20防水防塵等級
- 配備USB 3.0插口及無線充電裝置



電動升降檯(坐站兩用)
WPS-FDE104

- 中密度纖維板檯面+冷軋鋼板底座
- 檯面升降範圍23"-47"(600-1200mm)
- 最大承重88 lbs(40kg)
- 2檔記憶高度
- 遇阻回退功能
- 黑白兩種顏色可選



電動桌面工作站(坐站兩用)
WPS-GSD66HCE

- 中密度纖維板桌面+鋼製支架
- 桌面升降範圍6"-19"(150-490mm)
- 最大承重28.6 lbs(13kg)
- 鍵盤托最大承重4.4 lbs(2kg)
- 10000次升降測試
- 配備USB 2.0插口





Wipas Multipurpose Workstation
坐站兩用升降枱

UNIT Set

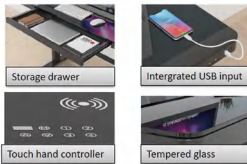

Code	Model	Lifting Format	Workstation	Weight Capacity	Lift	Worksurface Dimensions
481 8018	WPS-GHED121D-G2	Electronic	Fixed	110 lbs. (50kg)	720-1200mm	D600 x W1200 mm
481 8017	WPS-FDE104	Electronic	Fixed	88 lbs. (40kg)	600-1200mm	D600 x W600mm
481 8015	WPS-FDS107D-2	Manuel	Movable	22 lbs. (10kg)	750-1060mm	D550 x W700 mm
481 8016	WPS-FDS107F	Manuel	Movable	22 lbs. (10kg)	750-1060mm	D555 x W695mm



ERGOTRON WorkFit-D Sit-Stand
Desktop Workstation
坐站兩用桌面工作站

Loading: 65 lbs(29.5kg)
CF Technology Lifting
D23.5" x W47.5" x H30.6"-50.6"
(60 x 121 x 78-129cm)
承重: 65磅 (29.5kg)
CF 技術升降
深23.5" x 闊47.5" x 高30.6"-50.6"
(60 x 121 x 78-129cm)
24-271-927
Melamine Walnut Wood Grain 桃木桌面
• 001 8232

UNIT Set



by ergotron



Ergotron LearnFit® Sit-Stand Desk
流動企坐工作枱

- Adjust the desktop to the most comfortable, ergonomic height
- Backpack hook, cup holder, tablet slot and pencil tray for a no-mess experience
- 調整桌面至最舒適、符合人體工程學的高度
- 設有背包掛鈎、杯架、平板電腦插槽和筆架

UNIT Pc

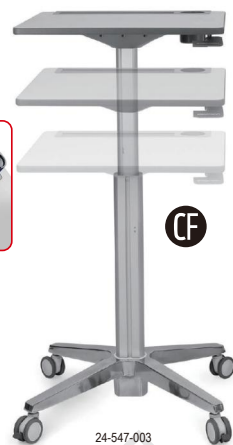

ERGOTRON LearnFit® Storage Bin
儲物筒

97-926-064
Grey

• 001 8210

UNIT Set



08

辦公室傢俱

Office Furniture



Sentry Electronic Safe
美國善衛防盜電子鎖夾萬

UNIT Pc

08

辦公室傢俱
Office Furniture



X125 • 762 2010



X105 • 762 2011



X055 • 762 2012



SFW123FSC • 762 2014



SFW082GTC • 762 2027



SFW082ESB • 762 2028



SFW123CSB • 762 2031



SFW123DTB • 762 2032



種類 Type	防盜電子鎖夾萬 Electronic Safe			防火(防水)電子密碼鎖夾萬 Electronic Fire Safe				
	762 2010	762 2011	762 2012	762 2014	762 2027	762 2028	762 2031	762 2032
產品編號 Product Code	762 2010	762 2011	762 2012	762 2014	762 2027	762 2028	762 2031	762 2032
型號 Model	X125	X105	X055	SFW123FSC	SFW082GTC	SFW082ESB	SFW123CSB	SFW123DTB
特點 Features								
電子鎖夾萬 Electric Key Lock Safe	✓	✓	✓	✓	✓	✓	X	X
連後備鑰匙 With Override Key Lock Safe	✓	✓	✓	X	X	X	X	X
UL防火測試; UL Classified Proven Fire Protection	X	X	X	1 Hour	1 Hour	1 Hour	1 Hour	1 Hour
ETL多媒體儲存設備防火測試 ETL verified for fire protection of CDs, DVDs, Memory Sticks and USB Drives	X	X	X	1 Hour	1 Hour	1 Hour	1 Hour	1 Hour
高空墮地測試 Verified Drop Test	X	X	X	15 尺(ft.)	15 尺(ft.)	15 尺(ft.)	15 尺(ft.)	15 尺(ft.)
結構 Structures								
ETL防水功能 ETL Water-resistant	X	X	X	✓	✓	✓	✓	✓
特硬門鎖 Lock	2	2	2	4	3	3	4	4
數字電子鎖 Digit Electronic Lock	2-8 Digit	2-8 Digit	2-8 Digit	5-Digit	5-Digit	5-Digit	5-Digit	5-Digit
調內式儲物格 Adjustable Shelf	1	1	X	1	1	1	1	1
存放手提電腦並擁有安全的電線接口 fits most laptops, bolt-down hardware included	✓	✓	✓	X	X	X	X	X
鑰匙架 Key tray	X	X	X	✓	✓	✓	✓	✓
可固定於牆身或地面 Can bolted to wall or floor	✓	✓	✓	✓	✓	✓	✓	✓
外圍尺寸(深 x 高 x 闊)毫米 Exterior (D x H x W)mm	370 x 270 x 430	370 x 225 x 430	270 x 220 x 350	491 x 453 x 415	491 x 348 x 415	491 x 348 x 415	491 x 453 x 415	491 x 453 x 415
內圍尺寸(深 x 高 x 闊)毫米 Interior (D x H x W)mm	294 x 266 x 426	294 x 221 x 426	220 x 216 x 346	302 x 349 x 319	292 x 244 x 319	292 x 244 x 319	302 x 349 x 319	302 x 349 x 319
重量(公斤) Weight (kg)	12.2	11	6.4	38.8	35.7	31.3	40	39.1
顏色 Color	黑色 Black	黑色 Black	黑色 Black	金屬灰 Gunmetal Gray		黑色及金屬灰 Black and Gunmetal Gray		金屬灰 Gunmetal Gray
生產地 Made in	中國 China			墨西哥 Mexico				





Sentry Advanced Electronic Fire Safe
美國善衛防火防水密碼鎖夾萬



STW123GDC • 762 2025



STW205GYC • 762 2029



SFW205BXC • 762 2030

08



Sentry Commerical Electronic Fire Safe
美國善衛防火商業鎖夾萬



S6370 • 762 2017



S6770 • 762 2018



S8371 • 762 2019



S8771 • 762 2020

種類 Type	密碼鎖夾萬 Electronic Safe			指紋密碼電子鎖夾萬 Biometric Electronic Safe		防火電子密碼鎖夾萬>Electronic Fire Safe	
產品編號 Product Code	762 2025	762 2029	762 2030	762 2017	762 2018	762 2019	762 2020
型號 Model	STW123GDC	STW205GYC	SFW205BXC	S6370	S6770	S8371	S8771
特點 Features							
電子鎖夾萬 Electric Key Lock Safe	✓	✓	✓	X	✓	X	✓
運後備鑰匙 With Override Key Lock Safe	✓	✓	✓	X	X	X	X
轉盤鎖夾萬 Combination Lock	X	X	X	✓	X	✓	X
UL防火測試; UL Classified Proven Fire Protection	2 Hours	2 Hours	1 Hour	1 Hour	1 Hour	1 Hour	1 Hour
ETL多媒體儲存設備防火測試 ETL verified for fire protection of CDs, DVDs, Memory Sticks and USB Drives	2 Hours	2 Hours	1 Hour	1 Hour	1 Hour	1 Hour	1 Hour
高空墮地測試 Verified Drop Test	15 尺(ft.)	15 尺(ft.)	15 尺(ft.)	15 尺(ft.)	15 尺(ft.)	15 尺(ft.)	15 尺(ft.)
結構 Structures							
ETL防水功能 ETL Water-resistant	✓	✓	✓	X	X	X	X
特硬門門 Lock	4	6	6	8	8	8	8
數字電子鎖 Digit Electronic Lock	5- Digit	5- Digit	5- Digit	X	4- Digit up to 16- Digit	X	4- Digit up to 16- Digit
指紋認證 Biometric Fingerprint Reading	X	X	✓	X	X	X	X
轉盤鎖組合數目 No. of Combination Lock	X	X	X	4	X	4	X
調內式儲物格 Adjustable Shelf	1 locking drawer	1 deep organizer /1 locking drawer	2 deep organizers	1 shelf / 1 locking drawer		2 shelves / 1 locking drawer	
存放手提電腦並擁有安全的電線接口 fits most laptops, bolt-down hardware included	X	X	X	X		X	
鑰匙架 Key tray	✓	✓	✓	X		X	
可固定於牆身或地面 Can bolted to wall or floor	✓	✓	✓	✓		✓	
外圍尺寸(深 x 高 x 闊)毫米 Exterior (D x H x W)mm	491 x 453 x 415	491 x 603 x 472	491 x 603 x 472	559 x 876 x 521		608 x 1210 x 646	
內圍尺寸(深 x 高 x 闊)毫米 Interior (D x H x W)mm	302 x 349 x 319	302 x 498 x 376	302 x 498 x 376	330 x 676 x 381		351 x 981 x 475	
重量(公斤) Weight (kg)	58.2	79.3	56.6	152		278.3	
顏色 Color	黑色>Black	黑色>Black	黑色>Black	淺灰色>Light Gray		淺灰色>Light Gray	
生產地 Made in	墨西哥>Mexico			韓國>Korea			
保用 Warranty	二年免費 2 year Free						

辦公室傢俱
Office Furniture



Sentry Fire/Water-proof File Box
美國善衛防火/防水文件保護箱

- UL Classified to protect your valuables in a fire for a 1/2 hour up to 1550°F (843°C)
- ETL Verified to protect your valuable items from flood damage up to 72 hours
- 通過UL標準測試，可在高達1550°F (843°C) 的火中保護您的貴重物品1/2小時
- ETL經過驗證可保護您的貴重物品免受長達72小時的水中測試

FHW40200

Exterior Size : D351 x W421 x H359mm

Interior Size : D206 x W305 x H295mm

Weight : 18.6 kg

• 762 2037





腳踏 / Step Stool

MV-T5/MV-T7



臺灣製造

最大承重150KG

已通過歐洲安全壓力測試



Tested according to:
EN14183:2003 based on



ISO9001:2000

德國萊因TUV是德國最知名的跨國認證檢測服務機構品牌之一，它是根據國際職業安全 and 健康要求進行產品測試的機構，產品必須嚴格依照安全性、便利性和易用性為指標。現時部份大規模機構更加希望製造商的产品，經過獨立機構的檢測和確認。

安全 凹凸防滑墊，已獲取歐洲安全壓力測試

實用 可承載重量約150KG

方便 附移動式滑輪，方便於時用時增加靈活性

穩固 收縮式滑輪，負重後自動收縮，防止滑倒

型號	尺寸	淨重	最高負重	顏色
MV-T5 (細)	頂部直徑: 28cm	3.4kg	150kg (約300磅)	黑 灰
	底部直徑: 41cm			
	高度: 38.5cm			
MV-T7 (大)	頂部直徑: 29cm	3.8kg	150kg (約300磅)	
	底部直徑: 43cm			
	高度: 43cm			



MV-T5



MV-T7

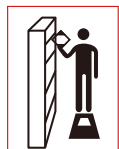

辦公室



倉庫



廚房



擦窗戶



換燈泡



用作座椅

3M

3M™ Adjustable Footrest
可調校高級適體腳踏

- Ergonomic design; helps prevent back, neck and leg strain as well as fatigue.
 - Exclusive 3M Safety-Walk™ surface
 - 特別為人體健康坐姿設計，有效地防止頸痠背痛
 - 表面採用3M Safety-Walk™安全防滑面，穩妥舒適
- Size : D330 x W457 x H102 mm
FR430

• **011 8033**
Size : D356 x W559 x H102 mm
FR530

• **011 8010**
UNIT Pc 



Fellowes

Fellowes Microban Adjustable Footrest
可調校高級適體防菌物料腳踏

- Microban® antimicrobial protection keeps product cleaner.
 - Adjustable footrest tilts 30 degrees forward or back and Height adjusts to 108 / 127 / 146mm.
 - 採用Microban®防菌物料製造，有效抑制細菌滋生及防止產生臭味。
 - 踏板傾斜角度可由 0° 至 30°作出靈活自由調較及3個踏板高度調較 108 / 127 / 146mm.
- Size : D333 x W455 x H108/127/146mm
FW8035001

• **211 8039**
UNIT Pc 



FW8035001

08

WIPAS
威帕斯

WIPAS Split Type Left And Right Free Adjustment Footrest
分體式左右自由調校腳踏

- 工程塑料材質
- 底部附防滑腳墊
- 分體式左右調節，可依需求調整從0°~20°不同的角度
- HIPS material
- Non-slip foot pads are attached to the bottom
- Split type left and right adjustment, tilt adjustment angle from 0°~20°

Size : D325 x W435 x H105 mm



WPS-FR1060

Fellowes

Fellowes Adjustable Footrest
可調校高級適體腳踏

Size : D330 x W450 x H120/150mm
48121

• **211 8015**
UNIT Pc 



WIPAS
威帕斯

WIPAS Easi-tread Footrest
可調校防滑膠面適體腳踏

- 防滑膠墊面+金屬底座材質
- 底部附防滑腳墊
- 可依需求調整從0°~20°不同的角度
- 三種調節高度
- Anti-slip rubber surface and steel base material
- Non-slip foot pads are attached to the bottom
- Tilt adjustment angle from 0°~20°, ensure a good fit
- 3 heights adjustment

Size : D326 x W415 x H103 mm

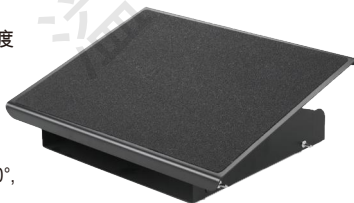

WPS-FR2096

WIPAS
威帕斯

WIPAS Easi-tread Footrest
可調校適體腳踏

- 工程塑料材質
- 底部附防滑腳墊
- 可依需求調整從0°~20°不同的角度
- HIPS material
- Non-slip foot pads are attached to the bottom
- Tilt adjustment angle from 0°~20°, ensure a good fit

Size : D353 x W473 x H95 mm

UNIT Pc 



WPS-FR1032

HOLLIES
ERGO ACCESSORIES

Hollies Easi-tread Footrest
可調校高級適體腳踏

- Loop angle positions for greater comfort. Surface Bumps Massage tired feet
- 高度調節，更加舒適，腳踏表面的凸塊設計，具有按摩作用

Size : D330 x W450 x H120 mm

HL-Z654

• **531 8102**
Size : D330 x W450 x H110-220mm
SL-655

• **531 8107**
UNIT Pc 



Z654



SL-655

1299 Step Stool
腳踏

- Maximum Support Weight: 100kg (220lbs)
 - With Non Slip Rubber Ring
 - 可載重100kg(220磅) 附防滑膠腳
- 1 kg, W450 x D442 x H455mm

• **001 8074**
UNIT Pc 



辦公室傢俱
Office Furniture

08

辦公室傢俱

Office Furniture

CBS Steel Filing Cabinet
直立式文件鋼櫃

- Suitable for F4 size suspension files.
- Central lock for safety

UNIT Pc



Code	Model	Drawer	Size (mm)
872 2111	R5015A	4	D635 x W460 x H1320
872 2115	R5015B	3	D635 x W460 x H1010
872 2120	R5015C	2	D635 x W460 x H710

CBS Steel Locker
文件儲物鋼櫃

- With label directory, ventilation and independent safety lock. Provide build-in closet with the choice of standard and extra large in size for coat-hanging
- 設有標籤索引、通風縫隙、獨立安全鎖，備有標準及特大可掛衣間隔供選擇

UNIT Pc



Code	Door	Size (mm)
872 2030	6	D500 x W900 x H1800
872 2031	4	D500 x W608 x H1800
872 2032	2	D500 x W317 x H1800
872 2033	15	D450 x W900 x H1800
872 2034	12	D450 x W900 x H1800
872 2035	9	D450 x W900 x H1800

An exact colour match on this catalogue cannot be guaranteed as batch.
圖像可能與實物顏色及質料有輕微偏差，只作參考用途。
Delivery within 6-8 weeks. Please note custom items are non-returnable.
以上產品6-8星期內送貨，所有訂造貨品均不能退換。

CBS Steel Open-Shelf Cabinet
文件鋼櫃

- Open-Shelf Cabinet, suitable for every-day-use files and folders
- Sliding-door design, prevent using up space of hallways. Together with 5-pin lock with parrot break ensure confidentiality of cabinets
- 開放式文件櫃，適合放置經常使用的文件及檔案
- 滑門設計，避免櫃門開啟時阻礙通道空間。配置專業門鎖，確保安全穩妥

UNIT Pc



開放式

Code	Shelves	Size (mm)
開放式 Open-Shelf Cabinet		
872 2002032	3 Shelf / 4層	D450 x W900 x H1800
872 2018032	2 Shelf / 3層	D450 x W900 x H1250
872 2019032	1 Shelf / 2層	D450 x W900 x H900
872 2020032	1 Shelf / 2層	D450 x W900 x H710
滑門式 Sliding-Door Cabinet		
872 2001032	3 Shelf / 4層	D450 x W900 x H1800
872 2015032	2 Shelf / 3層	D450 x W900 x H1250
872 2016032	1 Shelf / 2層	D450 x W900 x H900
872 2017032	1 Shelf / 2層	D450 x W900 x H710



滑門式

CBS Plastic Shutter Door Cabinet
捲門文件櫃

- Steel Frame with modern plastic shutter door design. Keeps everything tidy and accessible. Interlocked end slats in steel sections together with 5-pin lock with parrot beak ensure confidentiality of cabinets
- 不銹鋼櫃配以膠捲門設計，避免櫃門開啟時阻礙通道空間。鋼制門柱扣疊設計令捲門關合時互相緊扣，配置專業門鎖，確保安全穩妥

UNIT Pc

Code	Shelves	Size (mm)
872 2004032	4 Shelf / 5層	D460 x W1000 x H1980
872 2007032	2 Shelf / 3層	D460 x W1000 x H1250
872 2009032	2 Shelf / 3層	D460 x W1000 x H1020
872 2010032	1 Shelf / 2層	D460 x W1000 x H710
872 2036	4 Shelf / 5層	D460 x W1200 x H1980
872 2037	2 Shelf / 3層	D460 x W1200 x H1250
872 2038	2 Shelf / 3層	D460 x W1200 x H1020
872 2039	1 Shelf / 2層	D460 x W1200 x H710



可供配置附件 Accessories
1 掛快券用不銹鋼路軌 Steel Tube for Rail Hanging File
2 活動面板 Movable desk
3 掛快券 Hanging File Rack

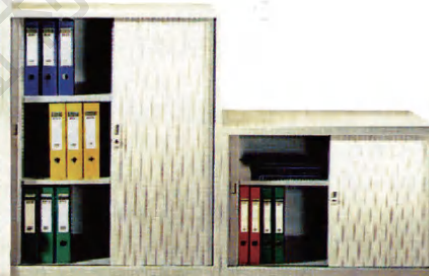

Sen wai Fire-Resistant Filing Cabinet
善衛防火櫃

- 2 Hours Fire Proof
- 2小時防火測試
- Drawer Inner Size 抽屜尺寸:
- D636 x W388 x H294mm
- 2 Drawer
- Size : D824 x W551 x H864mm
- Weight : 232 kg
- **762 2038**
- 4 Drawer
- Size : D824 x W551 x H1598mm
- Weight : 420 kg
- **762 2039**

UNIT Pc



2 Drawer

4 Drawer

Drawing Paper Mobile Rack
A0工程圖紙架

- Floor plan clip 6 pcs
- Clip can hold 15 sheets (width 800mm)
- Store plate with castor
- Material : aluminium clip, coated steel tube.
- 配6支(915mm)圖紙夾
- 可夾15張800mm寬圖紙
- 活輪支架
- 主要材料:
- 鋁合金圖紙架
- 噴塑鋼管側架

Size : D360 x W810 x H1410, 14 kg

UNIT Pc

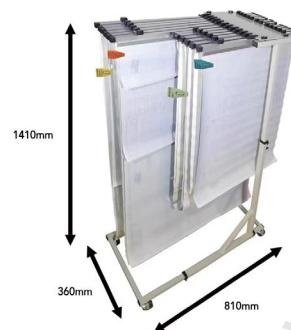

Bar 圖紙夾

- Alloy
- 合金
- W800mm

UNIT Pc



08

Industrial Container with Lid
揭蓋式物流膠箱

UNIT Pc



C-26

C-48

可加鎖頭

疊起方便運送

Trolley
專用運送車

UNIT Pc



可配運送車

Rectangular Container
物流膠箱

- C-7, 24L
- Inter : L547 x W323 x H142mm
- Outer : L590 x W350 x H155mm
- **002 2014**
- C-5, 67L, Red紅色
- Inter : L505 x W388 x H375mm
- Outer : L555 x W423 x H380mm
- **002 2015**
- Lid 蓋, 適合 C-5 使用, Red紅色
- C-4-1, L560 x W428 x H22mm
- **002 2077**

UNIT Pc

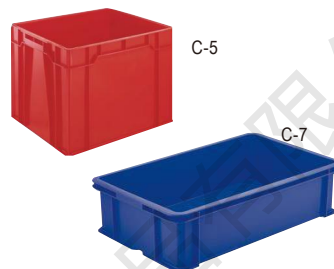

C-5

C-7

Logistics Box Model	Code	Colour	Size	Trolley Model	Code	Size
C-26 (47 Litre)	002 2052012	Grey	Inter : L510 x W360 x H295mm Outer : L551 x W397 x H315mm	1-R	009 9300	Inter : L487 x W357 x H35mm Outer : L508 x W379 x H160mm
	002 2052025	Blue				
C-48 (66 Litre)	002 2047012	Grey	Inter : L568 x W358 x H310mm Outer : L654 x W407 x H330mm	18-R	009 9302	Inter : L590 x W380 x H35mm Outer : L615 x W403 x H160mm
	002 2047025	Blue				

Kamly Flat Wheel Cart
金利木平板車

- Wooden plate with handle hole
- 4-way wheels easy to control
- 木板面有手抽孔, 四向轉容易控制

XO12402S, 20"x30"

• **009 9221**

UNIT Pc



DSK Flat Wheel Cart
樹脂平板車

Loading: 150 kg
DSK-101C
L715 x W470 x H145mm

• **009 9377**

UNIT Pc

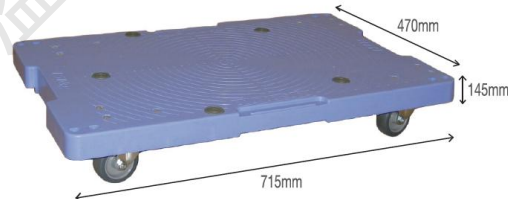

470mm

145mm

715mm

08

DSK Handle Platform Trolleys

樹脂手推車

DSK-101
Size : L715 x W460 x H860mm
Loading : 150 kg

• 009 9149

DSK-301
Size : L900 x W600 x H865mm
Loading : 300 kg

• 009 9151

DSK-102
Size : L715 x W460 x H915mm
Loading : 150 kg

• 009 9136

UNIT Pc



DSK-101



DSK-301



DSK-102

Foldable Trolley

折疊式手推車

HL-110
L740 x W480 x H860mm
Loading: 150 kg

• 009 9014

HB-210
L910 x W610 x H860mm
Loading: 300 kg

• 009 9031

UNIT Pc



Miracle®

Miracle Handle Foldable Trolley

樹脂手推車

MV-150
Size: L720 x W480 x H880mm
Loading: 150 kg

• 009 9269

MV-300
Size: L840 x W600 x H900mm
Loading: 300 kg

• 009 9270

UNIT Pc



辦公室傢俱
Office Furniture

2-Handle 2-Shelf with Zinc Plated

Mesh Trolleys

雙層有網邊雙向手推車

HL-120M, 2-shelf
Loading: 170kg
L820 x W480 x H1010mm

• 009 9211

UNIT Pc



Multi Purpose Foldable Luggage Cartridge

折疊式行李車

500129 (4-wheels)
Open Size : L390 x W390 x H1020mm
Folded Size : L390 x W11 x H640mm
Loading : 75kg

• 009 9436

UNIT Pc

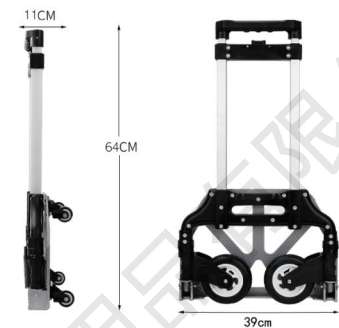

3-Tiers Services Trolleys

三層手推膠餐車

325-3, Loading: 25kg/layer(Total 75kg)
L842 x W428 x H922mm

• 009 9258

UNIT Pc



Multi-Shelf Table Trolleys

多層手推車

• 2 of 4-way wheels and 2 of fixed wheels
• 兩個四向轉兩個定向轉

UNIT Pc

L790 x W480 x H860mm
Loading: 170kg

HL-120, 2-shelf

• 009 9040

HL-130D, 3-shelf

• 009 9048



HL-120



HL-130

Neptune Magazine Rack (4s)

海皇星雜誌架

- Stainless steel tube. Coated metal plate. Plastic advertising board
 - 不銹鋼支柱，噴塑鋼板，塑膠廣告板
- C3304F
Size : D280 x W250 x H1320mm, 10kg
Pamphlet tray 資料台板 (D335 x W250 x H32mm), 4 pcs 層
- **334 9009**
C3308F
Size : D280 x W500 x H1320mm, 14kg
Pamphlet tray 資料台板 (D335 x W500 x H32mm), 4 pcs 層

• **334 9016**
UNIT Pc

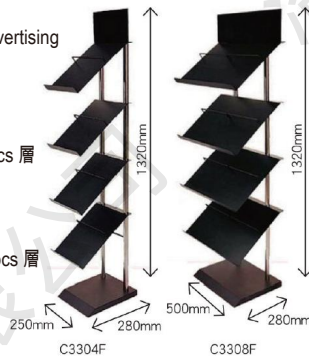

Seven layers Magazine Rack

七層雜誌架

- Coated metal plate
 - Suitable for most A4 or F4 size magazines and books.
 - 噴塑鋼板
 - 適合一般A4及F4雜誌和書籍
- Size : D290 x W260 x H1800mm, 11.8kg

UNIT Pc

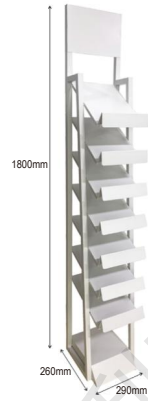

08

Newspaper & Magazine Rack

報紙及雜誌架

- Included 4 layers of newspaper clip(max 6 layers of newspaper clip).1 wire-trays to hold magazines
 - 內含四支報紙夾(最多可放六支報紙夾)，方便取閱
 - 一個鐵線籃，擺放雜誌更加整齊
- Size: W620 x D480 x H960mm
102

• **334 9001**
UNIT Set

Newspaper Bar
報紙夾

• Size H18 x W704mm (Round, 圓形)

710

• **274 9002**

UNIT Pc



(連四支報紙夾, 最多可放六支)

Magazine & Newspaper Protector

雜誌及報紙保護套

- Magazine 雜誌
- Suitable for most A4 or F4 size magazines and books.
 - 適合一般A4及F4雜誌和書籍, 美觀耐用
- Size : D16 x W228 x H312mm
632-A4, Clear

• **877 2001**

UNIT Pc

Newspaper Protector
報紙保護套

- Suitable for most A3 size magazines and newspapers
 - 適合一般A3雜誌和新聞紙, 美觀耐用
- Size : D16 x W300 x H400mm
634-EM, Clear

• **877 2002**

UNIT Pc

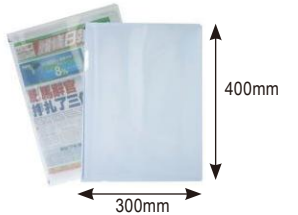
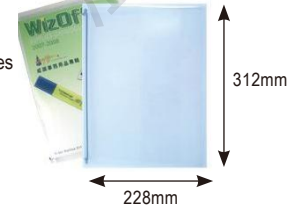

辦公室傢俱

Office Furniture

Stainless Steel Stand w/ Elastic Band

不銹鋼欄杆座連伸縮帶(單支)

Size: Ø320 x H890mm

Band Length

2m

• **339 9021**

3m

• **339 9022**

5m

• **339 9023**

UNIT Pc



Stainless Steel Double side Display Stand

不銹鋼雙面指示牌座(橫放)

- stainless steel
- transparency plastic
- 不銹鋼製造
- 透明膠片
- 見光: A4 L270 x H180mm
- 見光: A3 L390 x H270mm

A4, L345 x W250 x H1250mm

• **339 9011**

A3, L470 x W340 x H1300mm

• **339 9014**

UNIT Pc



TOOLS 五金工具

SELLERY®

SELLERY Tools

五金工具

Code	Model	Ref	Details
1 059 9001	22-312	Combination Padlock (3 digit) 可調號碼鎖(3位)	28mm 修改密碼不須工具
2 059 9002	22-319		30mm
3 059 9003	22-730	Brass Padlock 白銅鎖	30mm 附鎖匙2條
4 059 9004	22-740		40mm
5 059 9006	11-882	Screwdrivers 螺絲批	(-)(+), 6mm x 4" x #2 磁性批咀
6 059 9007	11-142	Precision Screwdrivers Set 彩色柄錄批	6pcs/Set 精細批咀
7 059 9055	45-634	Hammer 纖維柄錘	8oz 羊角錘
8 059 9049	Y29603	Plastic Tools Box 膠工具箱	17.2" x 8.2" x 7" 方便攜帶



UMBRELLA STAND 雨傘架

Tottie Umbrella Dryer 雨遮除水器

- 只要3至4次轉動雨遮，超級吸水纖維迅速去除雨遮雨滴

IP-TSW-01

Double-Hole (Long/Short) 雙頭(長/短遮)

3.6公升盛水容器2個

D300 x W780 x H691.5mm, 30kg

• 009 9458

IP-TST-01

Single-Hole 單頭

D320 x W320 x H700mm, 10kg, 3.6公升

• 009 9459



08

辦公室傢俱

Office Furniture

Umbrella Holder 雨傘筒

1023, L387 x W278 x H460mm

15 Holes

• 009 9298

1024, L463 x W323 x H603mm

24 Holes

• 009 9299



15 Holes



24 Holes



Jielisi Umbrella Stand 雨傘架

J-6, Size : L305 x W280 x H530mm

6 Holes

• 009 9194

J-21, Size : L658 x W366 x H570mm

21 Holes

• 009 9247



Automatic Umbrella Bag Machine 不銹鋼雨遮袋機

UPC/1000/SH

Single-Hole

單頭

• 009 9418

UPC/3000/SH

Double-Hole

雙頭, 有轆

• 009 9078



Umbrella bag for Machine 自動雨遮機袋

500pcs/Pack

Long : 120 x 670mm

• 162 1161

Short : 120 x 340mm

• 162 1162



UPC/1000/SH



UPC/3000/SH

Umbrella Stand 雨傘架

- Metal rack with Plastic Tray
- 金屬架配塑膠底盤

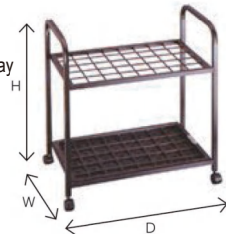

Code	Capacity	Size (mm)
339 9001	20	D385 x H610 x W375
339 9008	30	D495 x H610 x W385
339 9003	40	D635 x H610 x W385

SAFETY LADDER 安全工作梯

Platform Fiber Ladder 纖維玻璃鋼平台梯

- Max. load 150kg / Spacing between rungs 305mm

- 最高負重 150kg / 每層高度 305mm



折疊保護鎖

Huge 485 x 430mm

※折疊保護鎖及車輪需另行購買

Code	Model No	Step	Overall Open Height	Platform height	Reach height	Approx. Wt(kg)
009 9415	FA14-104	4	2.1m(7')	1.2m(4')	3.2m	14.9
009 9419	FA14-106	6	2.7m(9')	1.7m(6')	3.7m	17.2
009 9416	FA14-108	8	3.3m(11')	2.3m(8')	4.3m	20.5

Aluminium Ladders U-shape 鋁梯- U型

- TUV 及 GS 認證
- 符合歐洲標準 EN131
- 能負重: 150kg

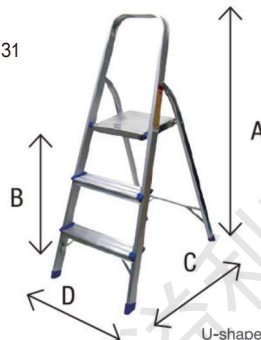

U-shape

Code	Step	A Height (mm)	B Height (mm)	C Width (mm)	D Width (mm)	Weight(kg)
009 9027	3	1255	655	685	430	3.40
009 9094	5	1675	1075	1062	483	4.75
009 9044	6	1895	1475	1203	510	6.10
009 9130	7	2110	1510	1376	535	6.70
009 9118	8	2325	1725	1549	560	7.40

Aluminium Ladders A-shape 鋁梯- A型

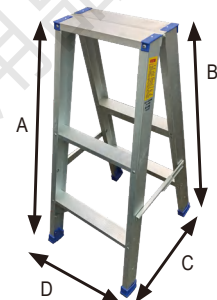

Code	Step	A Height (mm)	B Width (mm)	C Width (mm)	D Width (mm)	Weight (kg)
Max. load 100kg / Spacing between rungs 250mm 最高負重 100kg / 每層高度 250mm						
009 9500	3	890	880	520	420	2.45
Max. load 150kg / Spacing between rungs 237mm / 最高負重 150kg / 每層高度 237mm / TUV, GS認證及EN131標準						
009 9119	5	1100	1045	500	350	4.95
009 9341	6	1315	1218	510	350	5.95